

T775 Series 2000 Electronic Stand-Alone Controllers

APPLICATION GUIDE AND CROSS REFERENCE



IMPORTANT

The T775R is an operating control, not a limit or safety control. If used in applications requiring safety or limit controls, a separate safety or limit control device is required.

TABLE OF CONTENTS

T775 Application Tips	3	Multi-Stage Boiler Control (Reset) – T775P	18
Compatible Components	3	Multi-Stage Chiller Control (No Reset) – T775P	20
Temperature Sensors	3	4 Stage with Pump Output and Reset –	
Humidity Sensors (T775U only)	3	T775P using a T775S Expansion Module	21
Low Differential Pressure Sensors (T775U only)	3	4 Stage with Pump Output and Reset (continued) ...	22
Universal Sensors (T775U only)	3	3 Stage Reciprocating Chiller – T775L	23
Accessories	4	4 Stage Heat and 6 Stage Cool – T775L	24
Features	4	4 Stage Heat and 6 Stage Cool (continued)	25
T775 Operations	6	Pressure with a Variable	
Integral Action	6	Frequency Drive (VFD) – T775U	26
Derivative Action	6	Carbon Dioxide (CO2) Sensing – T775U	27
Differential vs. Throttling Range	6	Resetting Zone Air Temp Based on	
Setpoint High Limit	6	Outside Air Temp (2 stage cooling)	28
Reset Programming		Resetting Discharge Air Temp Based	
(T775L, T775P, T775R, and T775U models only)	7	on Return Air Temp (Modulating cooling valve)	29
T775 Applications	8	Using the T775R as a Differential	
Water Source Heat Pump Loop		Temperature Controller for Solar Water Heating	30
Water Controller – T775B	8	Maintaining Differential Temperature	
Chiller – T775B	9	for both Heating and Cooling	32
Chiller, Rotary Compressor – T775B	10	T775 Application Replacement Examples 33	
Cooling Tower Control – T775B2040	11	T775M2030 Replacement for W973A Logic Panel ..	33
Time-based Control of Fan,		T775R Replacement for W964F Aquatrol	
Pump, etc. — T775 (all models)	12	Panel with Floating Actuator	35
Damper or Valve Modulation – T775M or T775R	13	T775L Replacement for S984 Step Controller	38
Hot Water Reset – T775R	14	T775L Replacement for W7100C	
Chilled Water Reset – T775R	16	Discharge Air Controller	41
Multi-Stage Boiler Control (No Reset) – T775P	17	T775 Cross Reference	44
		Notes	55

T775 APPLICATION TIPS

- Q** Does the T775 save programmed values if the power is lost?
- A** Yes. The T775 has an EEPROM that saves all values entered and restores them once power is reapplied. The date and time settings are retained for 24 hours after a power outage. After a power loss of more than 24 hours, the date and time settings may need to be reentered. All other settings are stored permanently.
- Q** What is the time constant for the T775?
- A** The T775 standard sensor (50021579-001) has a time constant of approximately 8 seconds. The T775 samples sensor input every 100 milliseconds and updates the control and display every 1 second.
- Q** Can sensors be shared by several T775s to simplify installation or provide more stages?
- A** Each T775 must be wired to its own sensor(s). However, a benefit of the T775 controller's high accuracy is that there is no more than a 2° differential between any two T775 controllers.
- Q** Can a T775 be powered with dc voltage?
- A** No. The T775 controllers may be powered with 24 Vac, 120 Vac, or 240 Vac only, and a separate earth ground is required.
- Q** Is a separate earth ground required?
- A** Yes. Each T775 controller must have its own earth ground, regardless of the power source (24, 120, or 240 Vac). The earth ground must be connected to the earth ground terminal on the 24 Vac terminal block.
- Q** Can sensors be series-parallel wired to the T775 to provide an average temperature?
- A** Yes. Sensors can be series-parallel wired to the T775. In order to maintain control accuracy, the number of sensors wired must be of the n^2 power (i.e. 4, 9, 16, etc.).
- Q** How do I know that my selection or value has been entered?
- A** Once you have selected an item from a list or entered a value using the ▲ and ▼ buttons, pressing the ◀ or ▶ or **HOME** button accepts your selection or value and stores it in the controller's memory.
- Q** What are the T775 Series 2000 Controller specifications?
- A** Refer to the *T775 Series 2000 Electronic Stand-Alone Controllers - Specification Data* (form 63-1318).

COMPATIBLE COMPONENTS

Temperature Sensors¹

The controller accepts 1,097 Ohms PTC at 77° F (25° C):

- 50021579-001 – Standard sensor (included with all models except T775U2006 and NEMA 4X models)
- T775-SENS-STRAP – Strap on sensor with wiring box
- T775-SENS-WR – Water resistant with 5 foot leads (included with NEMA 4X models)
- T775-SENS-WT – Watertight with 6 foot lead
- T775-SENS-OAT – Outdoor air temperature sensor
- C7031B2005 – 6 inch duct mount with wiring box
- C7031D2003 – 5 inch immersion sensor with wiring box (use immersion well; P/N 50001774-001)
- C7031J2009 – 12 foot duct averaging sensor with wiring box
- C7046D1008 – 8 inch duct probe with mounting flange
- C7100D1001 – 12 inch fast response, duct averaging sensor with flange
- C7130B1009 – Room mount sensor

Humidity Sensors (T775U only)

The controller accepts 0-10 Vdc or 4-20 mA input with a range of 0-100%

H7625, H7635, and H7655 models (available in 2, 3, and 5% RH accuracy) can be used.

Low Differential Pressure Sensors (T775U only)

P7640A pressure transducer models with selectable pressure ranges can be used.

The controller accepts pressure sensors with a signal output of 0-10 Vdc or 4-20 mA for any output range within the following ranges (the minimum and maximum for the sensor output range can be adjusted within the following limits):

- 500 to 500 PSI
- 30.0 to 30.0 inches w.c.
- 3,000 to 3,000 Pa
- 3,000 to 3,000 kPa

Universal Sensors (T775U only)

The controller accepts 0-10 Vdc or 4-20 mA input for temperature, pressure, humidity, etc. C7232 and C7632 CO₂ sensors are also compatible but output is displayed in % instead of ppm. (Refer to Table 2 on page 35 and the T775U installation Instructions, form 62-0255-01.)

Actuators

For more information on compatible actuators or other Honeywell products, such as dampers and valves, go to www.customer.honeywell.com. From the home page select **Product Selection Tool** under **Products**.

- Spring return models: ML6425, ML7425, MS4105, MS4110, MS4120, MS7505, MS7510, MS7520, MS8105, MS8110, MS8120
- Non-spring return models: ML4161, ML6174, ML7161, ML7164, MN1010, MN6105, MN7505, MN8810

¹ See form 62-0265 - *Temperature Sensor for the T775 Series 2000 Stand-alone Controller*

Accessories

- 107324A – Bulb Holder, duct insertion
- 107408 – Heat Conductive Compound, 4 ounce
- 50001774-001 – Immersion Well, stainless steel 304, 1/2 in. threading

FEATURES

In Table 1 a check mark (✓) indicates that the controller model has this feature. A number indicates the quantity (e.g., the T775M2030 has 4 standard SPDT relay outputs), and “n/a” indicates the feature is not applicable to that controller model.

Table 1. T775 controller features by model number.

Feature	T775A2009	T775B2016	T775B2024	T775B2032	T775B2040	T775L2007	T775M2006	T775M2014	T775M2022	T775M2030	T775M2048	T775P2003	T775R2001	T775R2019	T775R2027	T775R2035	T775R2043	T775U2006	T775S2008
User Interface																			
2x4 inch LCD display with English language display	✓	✓	✓	✓	✓	✓	✓	✓	✓	✓	✓	✓	✓	✓	✓	✓	✓	✓	n/a
Keypad lockout	✓	✓	✓	✓	✓	✓	✓	✓	✓	✓	✓	✓	✓	✓	✓	✓	✓	✓	n/a
Applications																			
Standard heating/cooling	✓	✓	✓	✓	✓	✓	✓	✓	✓	✓	✓	✓	✓	✓	✓	✓	✓	✓	✓
Modulating							✓	✓	✓	✓	✓		✓	✓			✓	✓	
Boiler/Chiller	✓	✓	✓	✓	✓	✓	✓	✓	✓	✓	✓	✓	✓	✓	✓	✓	✓	✓	✓
Reset						✓						✓	✓	✓	✓	✓	✓	✓	✓
Stage (Loop) control of up to 12 relays						✓						✓							✓
Temperature, humidity, pressure, or other application requiring 0-10 Vdc or 4-20 mA input																		✓	
Expansion module (4-relays per module; 2 modules max.)																			✓
Power																			
24 or 120/240 Vac with separate earth ground	✓	✓	✓	✓	✓	✓	✓	✓	✓	✓	✓	✓	✓	✓	✓	✓	✓	✓	✓
Relay Outputs																			
SPDT	✓	✓	✓	✓	✓	✓	✓	✓	✓	✓	✓	✓	✓	✓	✓	✓	✓	✓	✓
Number of standard	1	2	4	2	4	4	0	4	2	4	2	4	4	4	2	2	0	2	4
Number of floating (each floating output eliminates 2 relays)	0	1	2	1	2	0	0	0	0	0	0	0	2	0	0	1	0	0	0
Runtime displayed on relays 1-4 (optional)	✓	✓	✓	✓	✓	✓	✓	✓	✓	✓	✓	✓	✓	✓	✓	✓	✓	✓	n/a
Configurable minimum off time	✓	✓	✓	✓	✓	✓	✓	✓	✓	✓	✓	✓	✓	✓	✓	✓	✓	✓	✓
Expandable to 12 relays using T775S expansion modules (4 relays per expansion module)						✓						✓							✓
Warm weather shutdown												✓							n/a
Modulating Outputs																			
Number of outputs	0	0	0	0	0	0	2	2	2	2	2	0	0	2	2	0	2	2	0
Independently selectable for 0-10 Vdc, 2-10 Vdc, 4-20 mA, or Series 90							✓	✓	✓	✓	✓			✓	✓		✓	✓	
Modulating high/low limit control								✓	✓	✓	✓						✓		n/a
Digital Output																			
Number of outputs	0	0	0	0	0	0	0	0	0	0	0	0	1	0	0	0	0	0	0
High, low, and differential alarm												✓							
Pump Output (configurable for last relay)																			
Number of outputs	0	0	0	0	0	0	0	0	0	0	0	1	0	0	0	0	0	0	1
Prepurge/Postpurge												✓							✓
Pump Exercise												✓							✓

Table 1. T775 controller features by model number. (Continued)

Feature	T775A2009	T775B2016	T775B2024	T775B2032	T775B2040	T775L2007	T775M2006	T775M2014	T775M2022	T775M2030	T775M2048	T775P2003	T775R2001	T775R2019	T775R2027	T775R2035	T775R2043	T775U2006	T775S2008
Sensor Inputs																			
Number of sensor inputs	1	2	2	2	2	2	2	2	2	2	2	3	2	2	2	2	2	2	0
Number of sensors included	1	1	1	1	1	1	1	1	1	1	1	3	2	2	2	2	2	0	n/a
1097 Ohms PTC at 77° F (25° C)	✓	✓	✓	✓	✓	✓	✓	✓	✓	✓	✓	✓	✓	✓	✓	✓	✓	✓	n/a
0-10 Vdc or 4-20 mA input for temperature, humidity, pressure, etc.																		✓	n/a
Calibration capability ±10° F (±6° C) or for T775U, ±10% of sensor range	✓	✓	✓	✓	✓	✓	✓	✓	✓	✓	✓	✓	✓	✓	✓	✓	✓	✓	n/a
1° sensed temperature accuracy	✓	✓	✓	✓	✓	✓	✓	✓	✓	✓	✓	✓	✓	✓	✓	✓	✓	✓	n/a
Sensed temperature range from -60° to 270° F (-51° to 132° C)	✓	✓	✓	✓	✓	✓	✓	✓	✓	✓	✓	✓	✓	✓	✓	✓	✓	✓	n/a
Digital Input																			
Number of inputs	1	1	1	1	1	1	1	1	1	1	1	1	1	1	1	1	1	1	1
Setpoints																			
Maximum number of setpoints	1	2	4	2	4	4	2	6	4	6	4	1	4	6	4	2	2	4	n/a
Range -40° to 248° F (-40° to 120° C)	✓	✓	✓	✓	✓	✓	✓	✓	✓	✓	✓	✓	✓	✓	✓	✓	✓	✓	✓
Maximum high setpoint option (irreversible)	✓	✓	✓	✓	✓	✓	✓	✓	✓	✓	✓	✓	✓	✓	✓	✓	✓	✓	n/a
Integral and Derivative Options																			
Integral time selectable from 0 to 3,600 seconds	✓	✓	✓	✓	✓	✓	✓	✓	✓	✓	✓	✓	✓	✓	✓	✓	✓	✓	n/a
Derivative time selectable from 0 to 3,600 seconds	✓	✓	✓	✓	✓	✓	✓	✓	✓	✓	✓	✓	✓	✓	✓	✓	✓	✓	n/a
Staging																			
Standard staging						✓						✓							✓
First on, first off												✓							✓
Equalized runtime												✓							✓
On delay and Off delay between stages						✓						✓							✓
Time Clock Scheduler																			
DST option	✓	✓	✓	✓	✓	✓	✓	✓	✓	✓	✓	✓	✓	✓	✓	✓	✓	✓	n/a
2 events per day	✓	✓	✓	✓	✓	✓	✓	✓	✓	✓	✓	✓	✓	✓	✓	✓	✓	✓	n/a
Selectable for setback, disable, or ignore to control all outputs	✓	✓	✓	✓	✓	✓	✓	✓	✓	✓	✓	✓	✓	✓	✓	✓	✓	✓	n/a
Enclosures																			
NEMA 1	✓			✓	✓	✓	✓			✓	✓	✓	✓	✓	✓	✓	✓	✓	✓
NEMA 4X		✓	✓					✓	✓										

T775 OPERATIONS

Integral Action

“Droop” and equipment hunting can be minimized by summing (integrating) the offset errors over time and adding this correction to the output voltage.

A non-zero value for the integral time will allow the controlled temperature to try and reach the setpoint value.

The integral time is factory set for 400 seconds and is similar to the response time of the T775 Series 1000 models. This is a good middle range and should satisfy many applications. The integral time can be increased for applications where sensed response is slow, and can be decreased for applications where sensed response is fast (e.g. discharge air control).

As a starting point, an optimal integral time for discharge air typically ranges from 12 to 200 seconds. An optimal integral time for room control typically ranges from 60 to 2,500 seconds. The purpose of integral action is to reduce or eliminate the offset from setpoint during steady state control that is often seen in proportional-only control.

Keep in mind that the controller is most sensitive to throttling range. Adjust the throttling range first before making any adjustment to integral time. Adjust throttling range to be as wide as possible to start, because this will provide the most stable control. Remember that the integral will eliminate the steady state error so you do not need to have a small throttling range to have accurate control. (Integral action allows for controlling to setpoint even with a wide throttling range.)

Derivative Action

Proportional-integral-derivative (PID) control adds the derivative function to PI control. The derivative function opposes any change and is proportional to the rate of change. The more quickly the control point (actual sensed temperature) changes, the more corrective action the PID system provides.

If the control point moves away from the setpoint, the derivative function outputs a corrective action to bring the control point back more quickly than through integral action alone. If the control point moves toward the setpoint, the derivative function reduces the corrective action to slow down the approach to the setpoint, which reduces the possibility of overshoot. The rate time setting determines the effect of the derivative action. The rate time is the time interval by which the derivative function advances the effect of the proportional action. In T775 controllers, the derivative rate time can range from 0 to 3,600 seconds. The higher the derivative setting, the greater the effect.

For all T775 Series 2000 controllers, the derivative default value is factory set to zero (no derivative control). It is strongly recommended that the derivative remain at zero (0) unless you have a very good reason to adjust it. Derivative control is not needed in the vast majority of HVAC applications.

Differential vs. Throttling Range

Differential is used for relay outputs, and throttling range is used for modulating outputs.

Setpoint and Differential

The following describes the relationship between setpoint and differential for heating and cooling. These settings are programmed for each output relay.

HEATING MODE SETPOINT AND DIFFERENTIAL

In heating mode, the differential is below the setpoint. The relay de-energizes when the temperature rises to the setpoint. As the temperature drops to the setpoint minus the differential, the relay energizes.

COOLING MODE SETPOINT AND DIFFERENTIAL

In cooling mode, the differential is above the setpoint. The relay de-energizes when the temperature falls to the setpoint. As the temperature rises to the setpoint plus the differential, the relay energizes.

Throttling Range

The throttling range brackets the setpoint setting, e.g., if the setpoint is 72° F (22° C) and the throttling range is 10° F (-12° C), then the effective throttling temperature range is 67° to 77° F (19° to 25° C). This applies to both modulating outputs and floating outputs.

Throttling Range for Modulating High or Low Limit

On models that support this feature, the throttling range for the modulating high or low limit positions the setpoint at the **end** of the throttling range. For example, with a high (Heat) limit at Sensor B of 200° F (93° C) and a throttling range of 10° F (-12° C), the modulating output controlling Sensor A begins to throttle back at 190° F (88° C), and fully closes at 200° F (93° C). Conversely, the throttling range for the low limit begins above the Cooling setpoint in the same manner.

Setpoint High Limit

You can set an irreversible setpoint high limit maximum value for any single setpoint temperature value. This prevents the user from setting any setpoint above the chosen high setpoint limit, which is useful for meeting some local codes.

Adjust the setpoint (at any output) to the desired maximum setpoint. Then, simultaneously press the **HOME**, **◀**, and **▶** buttons, and continue to press all three buttons for five seconds to set the setpoint high limit maximum to this value.

NOTE: You must press all three buttons at exactly the same time for this action to occur.

IMPORTANT

1. This action sets the maximum setpoint value of **all** outputs to the setpoint high limit maximum.
2. Setting the high limit setpoint maximum is **irreversible**. If you perform the action inadvertently and this setpoint adversely affects the control of your system, you must replace the controller.

Reset Programming (T775L, T775P, T775R, and T775U models only)

To program an output for reset, refer to the values as shown in the example below and in Fig. 1. Choose your own appropriate values for Sensor A maximum and minimum and Sensor B maximum and minimum.

Reset Example:

- Sensor A is the boiler sensor and Sensor B is the outdoor sensor.
- Maximum boiler temperature desired is 210° F (99° C) when the outdoor temperature is 20° F (-7° C).
- Minimum boiler temperature desired is 160° F (71° C) when the outdoor temperature is 70° F (21° C).

With the above settings example, when the outdoor temperature is 50° F (10° C), the effective setpoint is 180° F (82° C).

Setpoint Offset

NOTE: The Setpoint Offset is used for subsequent outputs only.

This value is the number of degrees plus (+) or minus (-) that you want the temperature to be offset from the first output's setpoint. See Fig. 1. For example, If you want the second output setpoint to be 10° F (-12° C) less than the first output setpoint, enter -10° F (-23° C).

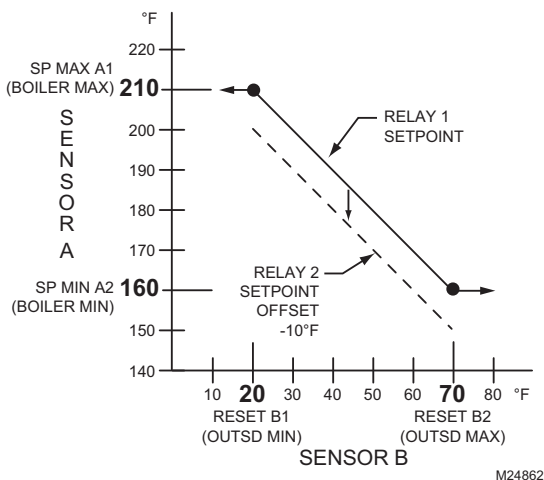

Fig. 1. Reset curve with offset for subsequent outputs.

The reset curve established when programming the first output (Fig. 1) is then used for **all** subsequent outputs that are configured for Reset = YES, and each of those outputs will be offset from this curve.

Choose Reset = NO for any outputs you do not wish to reset, then press the **HOME** button to record your selection.

NOTES:

1. A single reset curve is programmed for the first output and is used by all outputs setup for Reset.
2. For subsequent outputs, a setpoint *offset* is used if that output is also being Reset.

When Reset is programmed, the home screen conveniently displays the calculated Heat/Cool setpoint(s) for the outputs based on the reset curve.

Setback (Optional) Description

The Setback temperature option is available only if scheduling is enabled or the Digital Input Option is set to Setback.

This value is the number of degrees plus (+) or minus (-) that you want the temperature to be setback (offset) from the setpoint at a predetermined time.

For example, if you want the temperature to be 10° F (-12° C) less than the setpoint during setback mode, enter -10° F (-23° C). See Fig. 2.

In normal operations for heating, the offset will be a negative value; for cooling, the offset will be a positive value.

Setback (optional) Example:

Setback of -10° F (-23° C) is used to drop the temperature at night by 10° F (-12° C).

With the above settings example, when the outdoor temperature is 50° F (10° C), the effective setback setpoint is 170° F (77° C) 180° F (82° C) setpoint minus the 10° F (-12° C) setback).

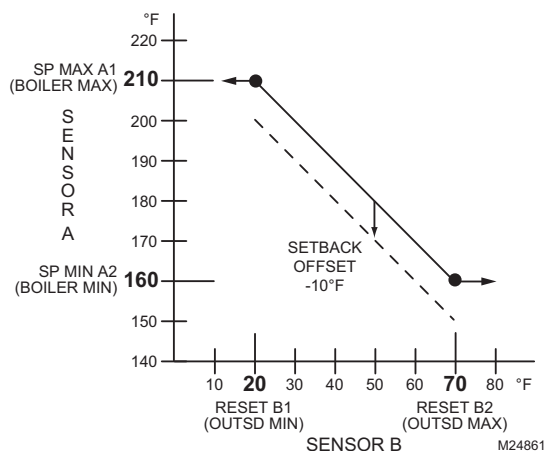

Fig. 2. Reset curve for first output with setback offset.

T775 APPLICATIONS

Water Source Heat Pump Loop Water Controller – T775B

Application Description

Water is circulated in a loop to remove waste heat and to provide cooling from a multiple heat pump system. In this example, the T775B controls heating and cooling systems to maintain the loop water temperature between preset upper and lower limits. Alarms are sounded to annunciate abnormally high or low water temperatures.

NOTE: T775R reset models can also be used in this application.

Sensor Designation

This device application only requires one sensor. Sensor A is mounted in a well, located in the main loop water line, before the water source heat pump take-offs.

Operation

In this example, if the loop water temperature drops to 55° F (13° C), heat is added to the system by the boiler (Relay 1) until it reaches the setpoint. If the temperature drops further, Relay 2 sounds the low temperature alarm at 54° F (12° C).

If the loop water temperature rises to 95° F (35° C), Relay 3 brings on cooling. If the temperature rises to 96° F (36° C), Relay 4 powers the high temperature alarm.

NOTE: If no alarms are present, relays 2 and 4 may be used as additional heating and cooling relays.

Programming Example

Relay 1: Enables boiler circuit

Program for:

- Heat
- Setpoint = 65° F (18° C)
- Differential = 10° F (-12° C)

Relay 2: Low temperature alarm circuit

Program for:

- Heat
- Setpoint = 55° F (13° C)
- Differential = 1° F (-17° C)

Relay 3: Enables cooling circuit (heat extraction)

Program for:

- Cool
- Setpoint = 85° F (29° C)
- Differential = 10° F (-12° C)

Relay 4: High temperature alarm circuit

Program for:

- Cool
- Setpoint = 95° F (35° C)
- Differential = 1° F (-17° C)

Setpoints may differ according to equipment manufacturers. See their recommendations.

IMPORTANT

After the desired value is selected, be sure to press the ◀ or ▶ or HOME button in order to save that value in the controller's memory.

Wiring

All output relays should have a common power wiring source, which may or may not be the same as the T775 power wiring. See Fig. 3.

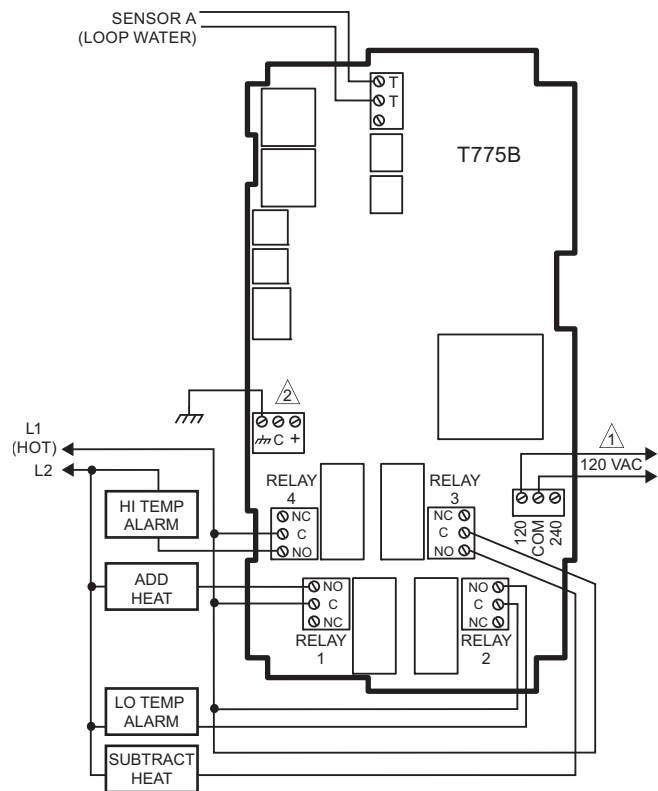

▲ POWER WITH 24 VAC OR 120/240 VAC AT THE APPROPRIATE TERMINAL BLOCK.

▲ 24 VAC POWER TERMINAL BLOCK.

M24863

Fig. 3. T775B wiring — loop water controller.

Chiller – T775B

Application Description

As the water temperature in the sump rises, the T775B sequentially cycles on the spray pump valve and two relays of fans. If the water temperature in the sump drops below 40° F (4° C), the T775B energizes a sump dump drain valve to prevent system freeze up.

NOTE: T775R reset models can also be used in this application.

Sensor Designation

This device application only requires one sensor. Sensor A is sensing sump water temperature.

Operation

In this example, the sump water temperature rises above the Cooling Relay 1 setpoint plus differential 65° F (18° C) to bring on the spray pump valve. If the temperature continues to rise, Cooling relays 2; 70° F (21° C) and 3; 75° F (24° C) energize the evaporation fans as needed.

If the sump water temperature drops below 40° F (4° C) (setpoint minus differential), the sump water freeze up protection is provided by energizing Heating Relay 4.

Programming Example

Relay 1: Controlling spray water pump and/or valve

Program for:

- Cool
- Setpoint = 60° F (16° C)
- Differential = 5° F (12° C)

Relay 2: Controlling fan # 1

Program for:

- Cool
- Setpoint = 65° F (18° C)
- Differential = 5° F (12° C)

Relay 3: Controlling fan # 2

Program for:

- Cool
- Setpoint = 70° F (21° C)
- Differential = 5° F (12° C)

Relay 4: Controlling dumping of sump at freeze condition

Program for:

- Heat
- Setpoint = 50° F (10° C)
- Differential = 10° F (-12° C)

IMPORTANT

After the desired value is selected, be sure to press the ◀ or ▶ or HOME button in order to save that value in the controller's memory.

Wiring

All output relays should have a common power wiring source, which may or may not be the same as the T775 power wiring. See Fig. 4.

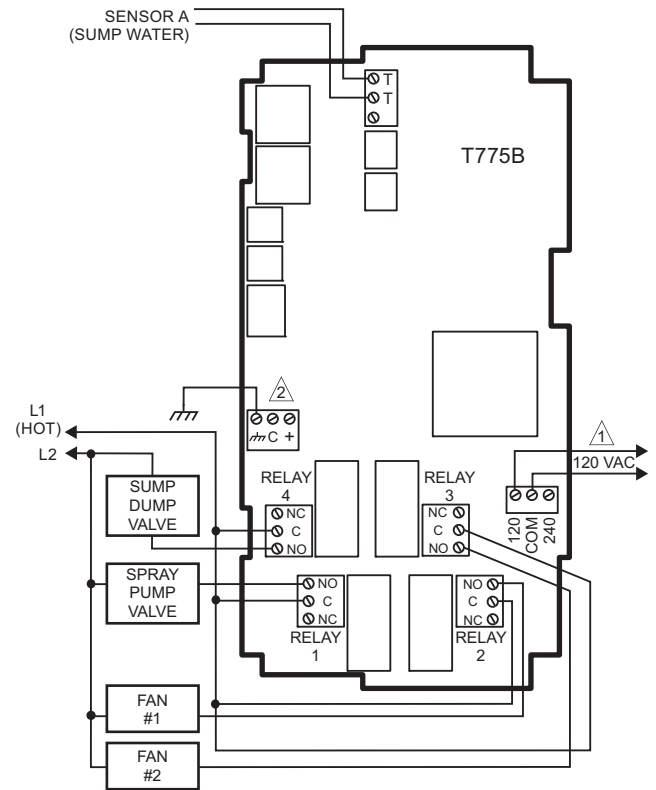

1 POWER WITH 24 VAC OR 120/240 VAC AT THE APPROPRIATE TERMINAL BLOCK.

2 24 VAC POWER TERMINAL BLOCK.

M24864

Fig. 4. T775B wiring — chiller.

Chiller, Rotary Compressor – T775B

Application Description

The T775B is controlling the discharge water temperature of a rotary compressor. The T775B provides an optional low temperature or low pressure cut-out circuit.

NOTE: T775R reset models can also be used in this application.

Sensor Designation

This device application only requires one sensor. Sensor A is sensing discharge water and controls 1 or 2 compressors.

Operation

In this example, the cooling capacity of a Rotary Compressor is controlled by a slide valve, which when moved towards open or closed allows more or less refrigerant into the compressor. Open and Closed solenoid valves position this slide valve. The T775B is configured such that two relays are used to position a single slide valve in a floating mode by controlling the respective solenoid valves. Capacity of rotary compressors may also be controlled by variable speed drives, not covered here.

Programming Example

Relay 1: Compressor #1 controlling the Close solenoid valve
Program for:

- Cool
- Setpoint = 52° F (11° C)
- Differential = 2° F (-17° C)

Relay 2: Compressor #1 controlling the Open solenoid valve
Program for:

- Cool
- Setpoint = 56° F (13° C)
- Differential = 2° F (-17° C)

Relay 3: Compressor #2 controlling the Close solenoid valve
Program for:

- Cool
- Setpoint = 56° F (13° C)
- Differential = 2° F (-17° C)

Relay 4: Compressor #2 controlling the Open solenoid valve
Program for:

- Cool
- Setpoint = 60° F (16° C)
- Differential = 2° F (-17° C)

IMPORTANT

After the desired value is selected, be sure to press the ◀ or ▶ or HOME button in order to save that value in the controller's memory.

Wiring

All output relays should have a common power wiring source, which may or may not be the same as the T775 power wiring. See Fig. 5.

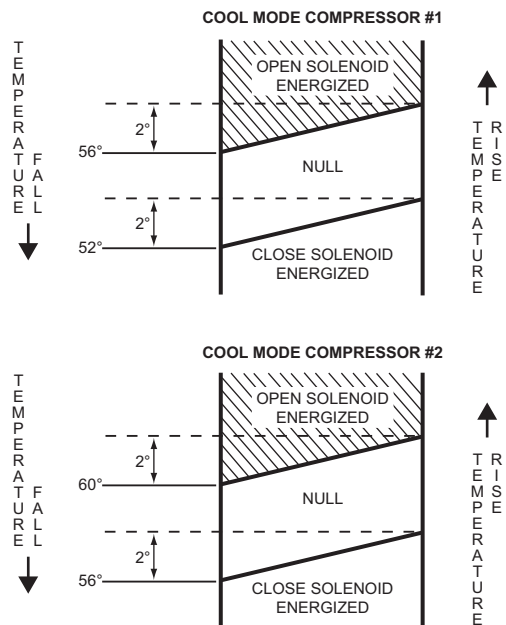
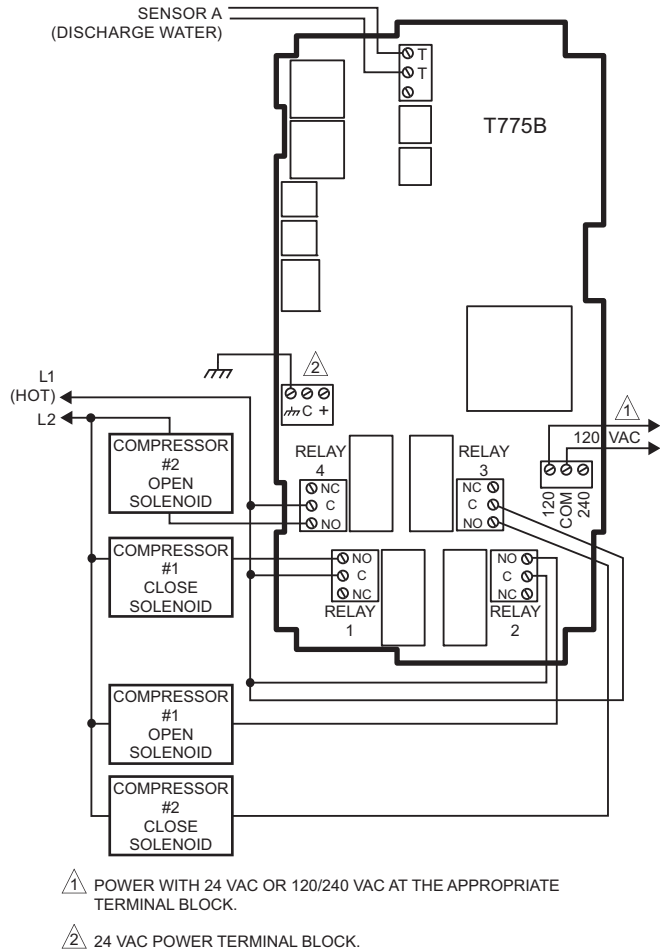

M24865

Fig. 5. T775B wiring — chiller, rotary compressor.

Cooling Tower Control – T775B2040

Application Description

The T775B2040 is controlling a cooling tower fan, based on two sensor inputs, to control the low and high fan speeds and provide cold weather shutdown.

NOTE: T775R2001 reset model can also be used in this application.

Sensor Designation

This device application requires two sensors:

- Sensor A is sensing the sump temperature.
- Sensor B is sensing the outside air temperature.

Operation

As the sump temperature increases, the low fan speed is energized by Relay 1. On further increase in temperature, Relay 2 closes, which energizes the high fan speed and shuts off the low fan speed. Relay 3 provides cold weather shutdown of the fan. Relay 3 is wired in series with the common wire of relays 1 and 2, so when Relay 3 breaks at 55° F (13° C), power to the fan is interrupted.

Programming Example

Optional: In Setup, label sensors A and B as desired.

Relay 1: Control to the fan low speed based on the sump temperature.

Program for:

- Setpoint = 65° F (18° C)
- Differential = 5° F (12° C)
- Cool
- Sensor A

Relay 2: Control to the fan high speed based on the sump temperature

Program for:

- Setpoint = 70° F (21° C)
- Differential = 5° F (12° C)
- Cool
- Sensor A

Relay 3: Control to the fan cutoff based on the outside air temperature

Program for:

- Setpoint = 55° F (13° C)
- Differential = 1° F (12° C)
- Cool
- Sensor B

IMPORTANT

After the desired value is selected, be sure to press the ◀ or ▶ or HOME button in order to save that value in the controller's memory.

IMPORTANT

By programming the Relay 3 setpoint at 55° F (13° C), the T775 is wired to cutoff power to the cooling fan. Once the outside air temperature rises above 55° F (13° C), relays 1 and 2 control the fan speed based on their setpoints for Sensor A Sump.

Wiring

All output relays should have a common power wiring source, which may or may not be the same as the T775 power wiring. See Fig. 6.

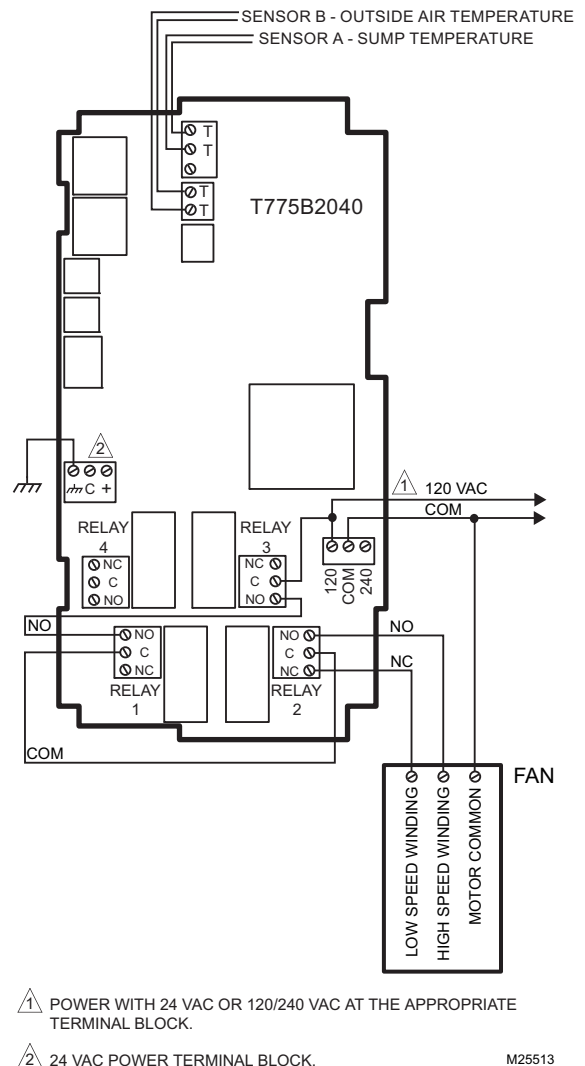

Fig. 6. T775B2040 wiring for cooling tower control.

Device Checkout

The T775B performance can be checked out to determine if proper operation exists.

For example, when the outside air temperature is at 55° F (13° C) or less, the fan should be off. Use the alternate Home screens to verify that the fan is on or off, based on the outside air temperature (Sensor B).

NOTE: The alternate Home screens do not show live updates of the sensor temperature. They show the temperature only at the moment the button is pressed.

1. From the Home screen, use the ▶ button to verify the setpoint temperature for Relay 3.
2. Then, press the HOME button to view the actual outside air temperature (Sensor B).

Time-based Control of Fan, Pump, etc. – T775 (all models)

Application Description

In this example, the T775B is able to energize a fan, pump, lights, economizer, or other device based on a daily time schedule rather than based on temperature.

Operation

In this example, one relay will energize at 6:00 a.m. and de-energize at 6:00 p.m. daily to operate a fan, pump, or anything at all.

Configuration Example

Place a 1,000 Ohm resistor at Sensor B (to simulate a constant 32° F (0° C) temperature reading).

Wire the device to the normally open contacts on a relay. Relay 1 is used in this example. See Fig. 7

Programming Example

Program in Setup for:

- Outputs
- Options
- Use Scheduler = YES

Program in Schedule for:

- Options
- Set Date = current date¹
- Set Time = current time
- Set Daylight = YES or NO
- Mon-Fri
- E1 Setpoint = Setpoint
- E1 Time = 06:00 AM
- E2 Setpoint = Setback
- E2 Time = 6:00 PM

Relay 1: Control the device (fan, pump, etc.)

Program for:

- Setpoint = 0° F (-17° C)
- Differential = 1° F (-17° C)
- Sensor = Sensor B
- Setback = 100° F (38° C)
- Action = Cool

Now the relay will close at 6:00 a.m. and open at 6:00 p.m., daily.

¹ The date must be set before the time is set.

NOTE: Keep in mind that if the scheduler is energized, all relays will follow the time schedule. If you do not want some outputs to go into a setback mode, choose Scheduler = NO for those outputs, or program the setpoint and setback to the same temperature.

IMPORTANT

After the desired value is selected, be sure to press the ◀ or ▶ or HOME button in order to save that value in the controller's memory.

Wiring

All output relays should have a common power wiring source, which may or may not be the same as the T775 power wiring.

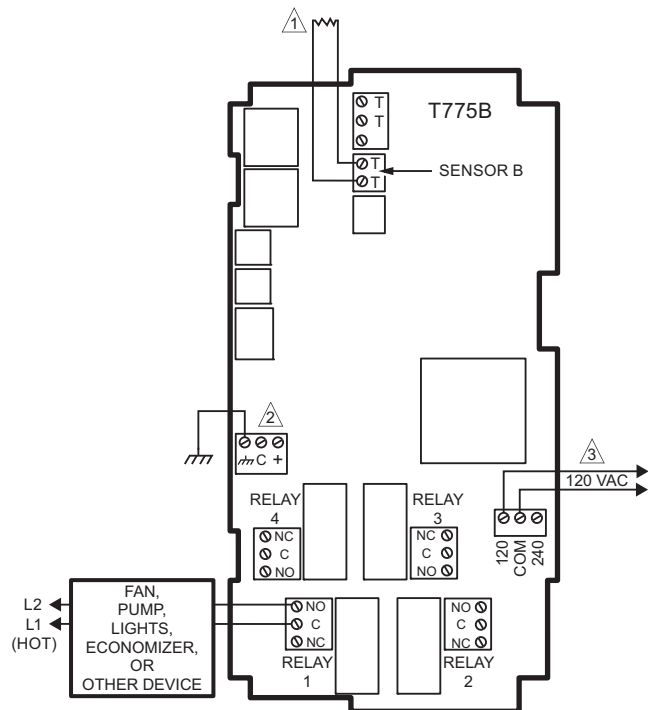

▲ INSERT 1000 OHM RESISTOR.

▲ 24 VAC POWER TERMINAL BLOCK.

▲ POWER WITH 24 VAC OR 120/240 VAC AT THE APPROPRIATE TERMINAL BLOCK.

M28021

Fig. 7. T775B wiring for time-based fan, pump or other device.

Damper or Valve Modulation – T775M or T775R

Application Description

In this example, a T775M is controlling an actuator, based on temperature input, to modulate a damper or valve.

Sensor Designation

This device application requires one sensor.

- Sensor A is sensing outside temperature

NOTE: Sensor A or Sensor B can be used in this application.

Programming Example

Program in Setup for:

- Modulating Output (MOD) 1:
 - Type = 2-10V (or whatever output signal is preferred)
 - Minimum Output % = 0% (range is 0-100%)

Modulating Output 1: Enable actuator circuit

Program for:

- Setpoint = 120° F (49° C)
- Throttling Range = 10° F (-12° C)
- Sensor = Sensor A
- Heat or Cool

IMPORTANT

After the desired value is selected, be sure to press the ◀ or ▶ or HOME button in order to save that value in the controller's memory.

Wiring

See Fig. 8 and 9 for wiring connections for the T775M with examples of an MS75xx actuator and an ML7425 valve actuator.

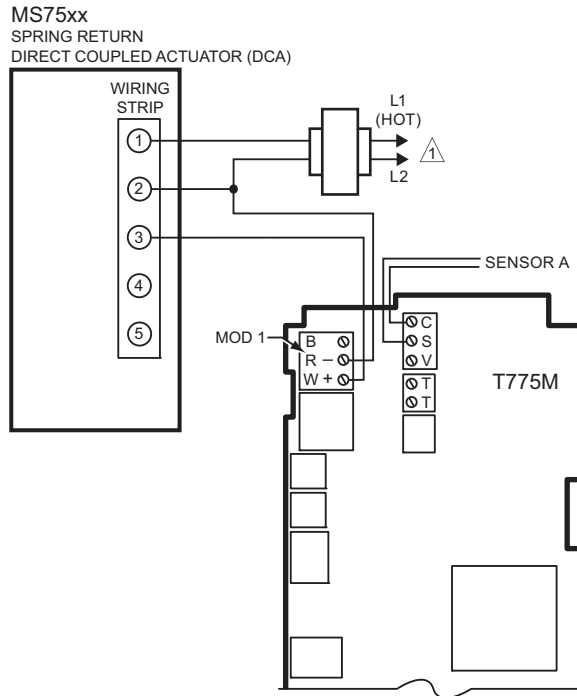

⚠ POWER SUPPLY. PROVIDE DISCONNECT MEANS AND OVERLOAD PROTECTION AS REQUIRED.

M24881A

Fig. 8. T775M wiring — damper modulation (2-10 Vdc shown).

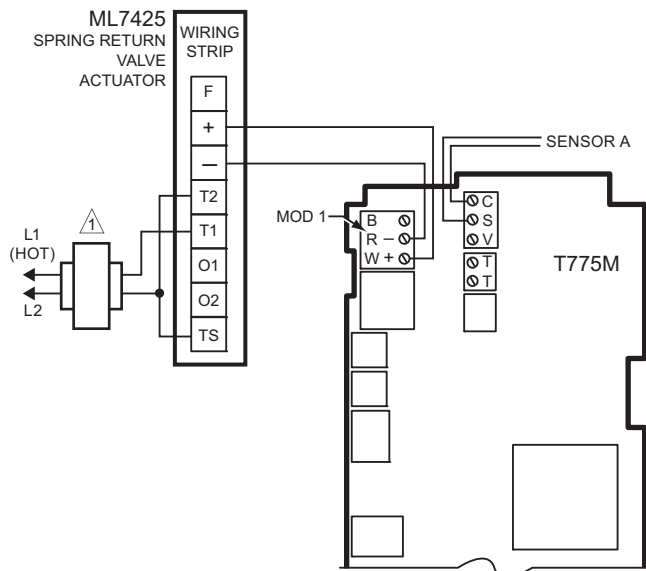

⚠ POWER SUPPLY. PROVIDE DISCONNECT MEANS AND OVERLOAD PROTECTION AS REQUIRED.

M28042

Fig. 9. T775M wiring — valve modulation (2-10 Vdc shown).

Hot Water Reset – T775R

Application Description

The T775R is controlling the boiler water temperature with two stages (relays), based on outside temperature using a reset curve and an offset for Relay 2.

Sensor Designation

This device application requires two sensors.

- Sensor A is sensing hot water discharge temperature of the boiler.
- Sensor B is sensing outside air temperature

Operation

In this example, when the outside temperature reaches 70° F (21° C), the desired water temperature of the boiler is 160° F (71° C). Likewise, when the outside temperature drops to 20° F (-7° C), the hot water temperature needs to be 210° F (99° C). See Fig. 10.

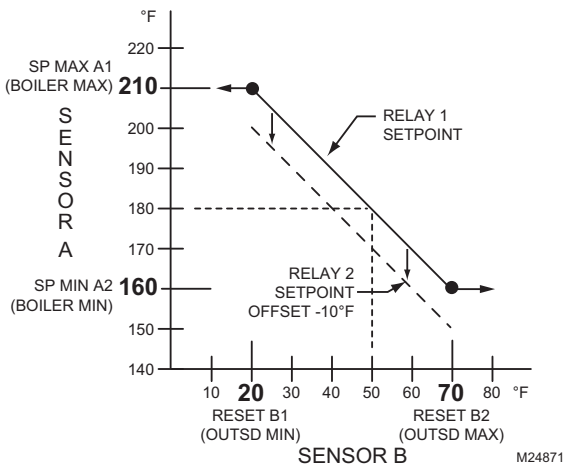

Fig. 10. Hot water reset curve.

Programming Example

Program in Setup:

Press and hold the **MENU** button for 5 seconds to enter Setup mode. Select the Outputs menu, and then select:

- MOD 1 → Reset = YES-BOILER
- # Relays = 2
- Relay 1 → Reset = YES-BOILER
- Relay 2 → Reset = YES-BOILER

Relay 1: Control to the discharge water temperature

Program for: (Refer to the reset curve in Fig. 10.)

- Boiler Max = 210° F (99° C)
- Outside Min = 20° F (-7° C)
- Boiler Min = 160° F (71° C)
- Outside Max = 70° F (21° C)
- Differential = 20° F (-7° C)
- Sensor A
- Heat

Relay 2: Control to the discharge water temperature

Program for:

- Setpoint Offset = -10° F (-12° C) (See Fig. 11)
- Sensor A
- Heat

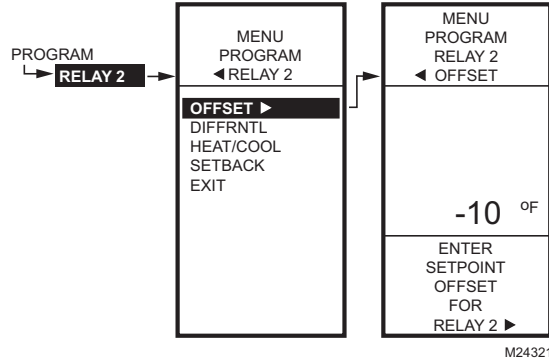

Fig. 11. Program mode — Relay 2 offset.

IMPORTANT

After the desired value is selected, be sure to press the ◀ or ▶ or HOME button in order to save that value in the controller's memory.

IMPORTANT

By programming the boiler setpoint at 210° F (99° C) the T775 has established 210° F (99° C) as the highest operating point that will be allowed when the outside temperature falls below 20° F (-7° C). As the outside temperature increases above 20° F (-7° C), the boiler will be reset downward per the reset ratio until it reaches the minimum setpoint, 160° F.

Assuming an outside temperature of 20° F (-7° C), Fig. 12 describes the actions of relays 1 and 2 to control the boiler temperature. As the boiler temperature falls below 210° F (99° C), Relay 1 activates (Relay 1 Differential is 20° F (-7° C), so relay closes at 190° F (88° C). If Relay 1 cannot raise the boiler temperature and the boiler temperature continues to fall to 180° F, Relay 2 activates (Relay 2 differential is 20° F (-7° C) 180° to 200° F (82° to 93° C). When the boiler is able to reach 200° F (93° C), then Relay 2 deactivates and Relay 1 remains active until the temperature reaches 210° F (99° C).

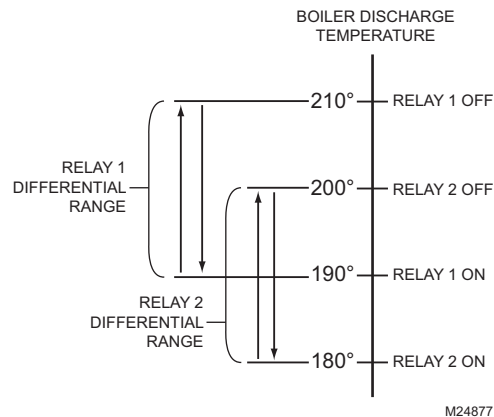

Fig. 12. Relay actions.

NOTE: The hot water reset application continues on the next page.

Hot Water Reset (continued)

Wiring

All output relays should have a common power wiring source, which may or may not be the same as the T775 power wiring. See Fig. 13.

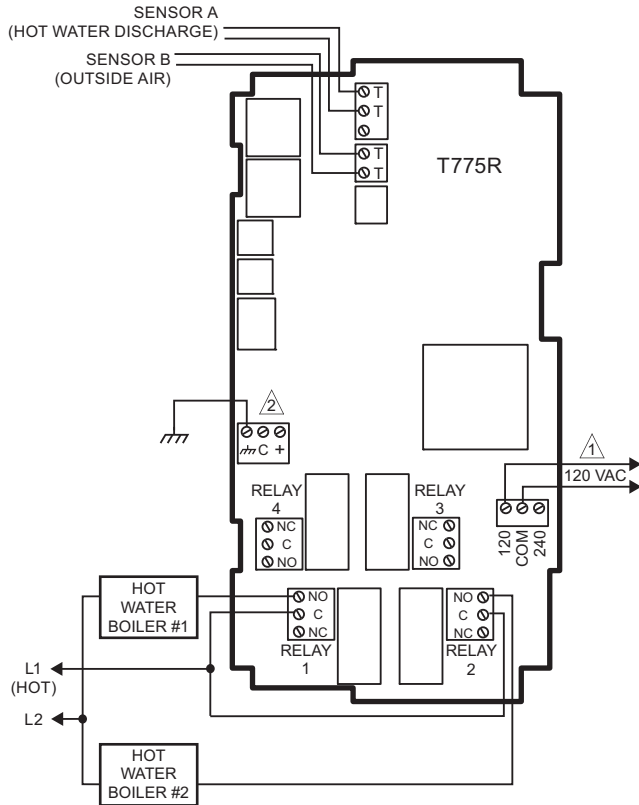

POWER WITH 24 VAC OR 120/240 VAC AT THE APPROPRIATE TERMINAL BLOCK.

24 VAC POWER TERMINAL BLOCK.

M24872

Fig. 13. T775R wiring — hot water reset.

Device Checkout

The T775 performance can be checked out to determine if proper operation exists.

For example, when the outside air temperature is at 50° F (10° C), the boiler setpoint temperature should be 180° F (82° C). See Fig. 14. Use the alternate Home screens to check that the effective setpoint is adjusting correctly based on the outside air temperature (Sensor B).

NOTE: The alternate Home screens do not show live updates of the sensor temperature. They show the temperature only at the moment the button is pressed.

1. From the Home screen, use the ► button to verify the setpoint temperature for each output.
2. Then, press the **HOME** button to view the actual outside air temperature (Sensor B).

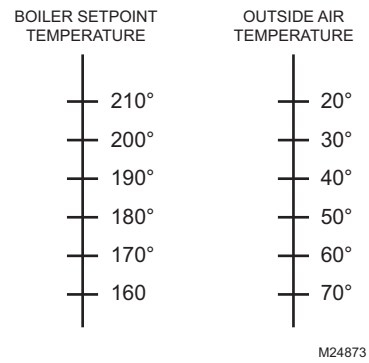

M24873

Fig. 14. Boiler discharge temperature setpoint vs. outside temperature.

Chilled Water Reset – T775R

Application Description

The T775R is controlling the chiller water temperature, based on outside temperature using a reset curve.

Multiple stages can also be controlled by using an offset from the main setpoint for the subsequent relay outputs. When enabling multiple stages for reset, each stage can have its own programmable offset from Relay 1 (stage 1).

Sensor Designation

This device application requires two sensors.

- Sensor A is sensing the water temperature of the chiller.
- Sensor B is sensing outside air temperature.

Operation

In this example, when the outside temperature reaches 90° F (32° C), the desired water temperature of the chiller is 45° F (7° C). Likewise, when the outside temperature drops to 70° F (21° C), the chilled water temperature needs to be 60° F (16° C).

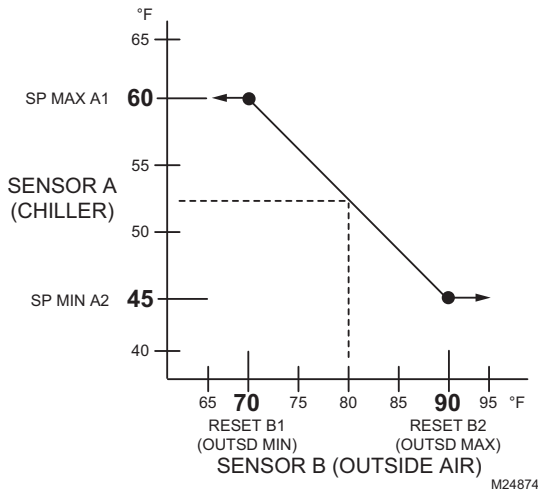

Fig. 15. Chiller reset curve.

Programming Example

Program in Setup:

Press and hold the **MENU** button for 5 seconds to enter Setup mode. Select the Outputs menu, and then select:

- MOD 1 → Reset = YES-OTHER
- # Relays = 1
- Relay 1 → Reset = YES-OTHER

Relay 1: Control to the chilled water temperature
Program for: (Refer to the reset curve in Fig. 15.)

- Setpoint Max A1 (Chiller) = 60° F (16° C)
- Reset B1 (Outside Min) = 70° F (21° C)
- Setpoint Min A2 (Chiller) = 45° F (7° C)
- Reset B2 (Outside Max) = 90° F (32° C)
- Differential = 10° F (-12° C)
- Cool

IMPORTANT

After the desired value is selected, be sure to press the ◀ or ▶ or **HOME** button in order to save that value in the controller's memory.

IMPORTANT

By programming the Chiller setpoint at 45° F (7° C) the T775 has established 45° F (7° C) as the lowest operating control point that will be allowed during reset with the above conditions satisfied.

Wiring

All output relays should have a common power wiring source, which may or may not be the same as the T775 power wiring.

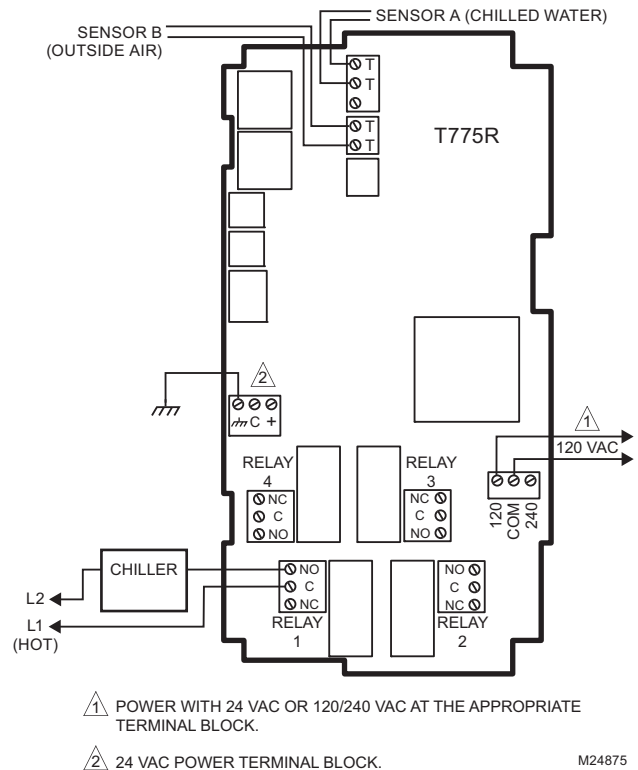

Fig. 16. T775R wiring — chilled water reset.

Chilled Water Reset (continued)

Device Checkout

The T775 performance can be checked out to determine if proper operation exists.

For example, when the outside air temperature is at 80° F (27° C), the chiller water temperature should be 52.5° F (11° C). See Fig. 17. Use the alternate Home screens to check that the effective setpoint is adjusting correctly based on the outside air temperature (Sensor B).

NOTE: The alternate Home screens do not show live updates of the sensor temperature. They show the temperature only at the moment the button is pressed.

1. From the Home screen, use the ► button to verify the setpoint temperature for each output.
2. Then, press the **HOME** button to view the actual outside air temperature (Sensor B).

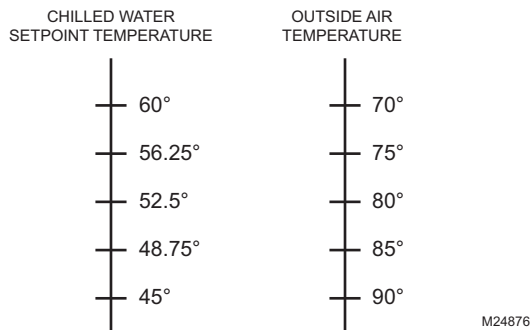

Fig. 17. Chiller setpoint vs. outside temperature.

Multi-Stage Boiler Control (No Reset) – T775P

Application Description

The T775P is providing multistage boiler control based on the boiler's discharge water temperature. The T775P uses the fourth output relay to energize the primary pump.

Sensor Designation

This device application requires two sensors.

- Sensor A is sensing discharge water and is used to control 3 boiler stages.
- Sensor C is sensing the return water.

NOTE: Control can be to either Sensor A or C.

Operation

In this example, as the heating load increases, additional stages of heat will cycle ON as the boiler water temperature decreases. The T775P will stage three boilers to provide sufficient heating. (See Fig. 18.) The primary circulating pump energizes whenever any stage is energized.

Programming Example

Program in Setup:

Press and hold the **MENU** button for 5 seconds to enter Setup mode. Select the Outputs menu, and then select:

- # Stages = 3 (T775 assigns pump to Relay 4)
- Options → On Delay and Off Delay:
Seconds = 0 to 3,600 (default is 0)
- Options → WWSD = YES or NO
Temperature = 30 to 100° F (-1 to 38° C)
- STG4/Pump: (Relay 4 controls the pump output)
Enable = YES
Exercise = YES or NO
Prepurge = -300 to 300 seconds (default is 0)
Postpurge = 0 to 300 seconds (default is 0)

NOTES:

1. A positive Prepurge time causes the pump to energize before the first stage energizes. A negative time causes the pump to energize after the first stage energizes.
2. The Postpurge time causes the pump to run for the set number of seconds after the last stage de-energizes.

Return to the Setup menu, and select Alarms:

- High Alarm = YES
- High Limit = 220° F (93° C)

NOTE: This model has Equal Runtime options, which can be configured with the Lead Lag output option in Setup.

Stages 1-3: Control to the discharge water temperature

Program for:

- Setpoint = 200° F (93° C)
- Throttling Range = 18° F (-8° C)
- Sensor A
- Heat

IMPORTANT

After the desired value is selected, be sure to press the ◀ or ▶ or HOME button in order to save that value in the controller's memory.

Refer to the staging diagram in Fig. 18 for individual stage behavior.

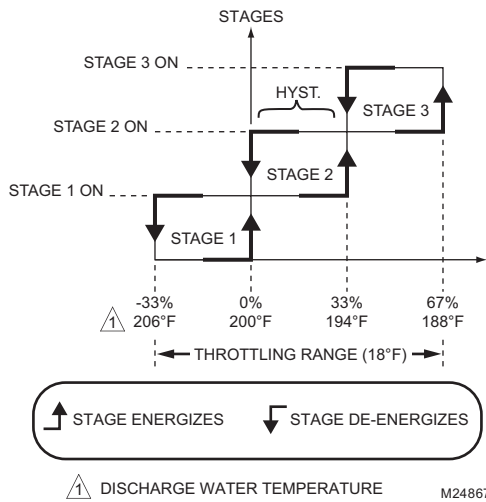

Fig. 18. Boiler control staging behavior (when the effective setpoint = 200° F).

Wiring

All output relays should have a common power wiring source, which may or may not be the same as the T775 power wiring. See Fig. 19.

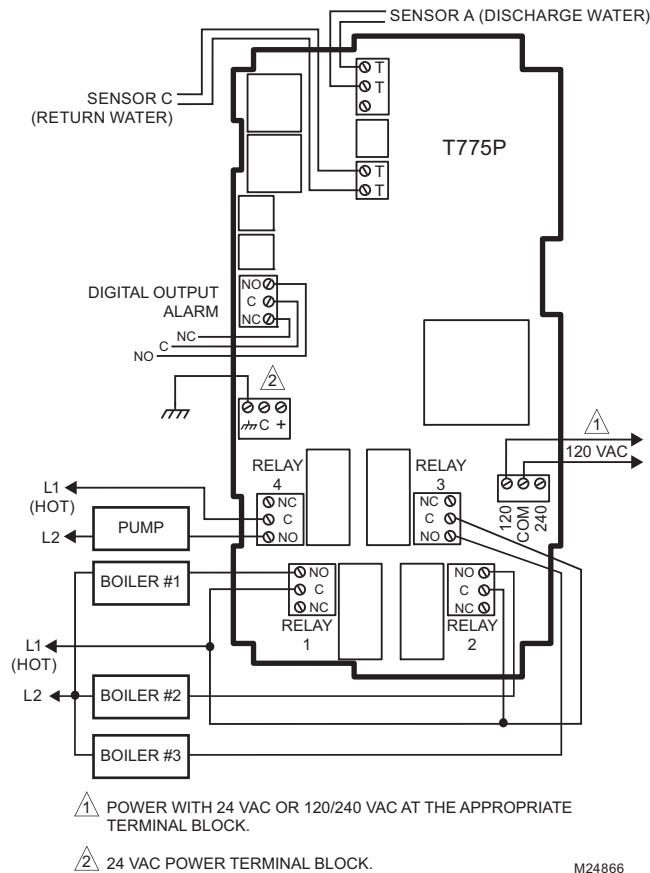

Fig. 19. T775P wiring — multi-stage boiler control (no reset).

Multi-Stage Boiler Control (Reset) – T775P

Application Description

The T775P is providing multistage boiler control based on the boiler's discharge water temperature. The T775P uses the fourth output relay to energize the primary pump.

Any number of stages from 1 to 12 can be configured (T775P and T775L models). The throttling range is divided equally among the stages.

Sensor Designation

This device application requires three sensors.

- Sensor A is sensing discharge water and is used to control 3 boiler stages.
- Sensor B is sensing outside temperature and is used for reset.
- Sensor C is sensing the return water temperature.

NOTE: Control can be to either Sensor A or C.

Operation

In this 3-stage example, as the heating load increases, additional stages of heat will cycle ON as the boiler water temperature decreases. The T775P will stage three boilers to provide sufficient heating. See Fig. 20 for staging behavior.

The primary circulating pump energizes whenever any stage is energized.

Programming Example

Program in Setup:

Press and hold the **MENU** button for 5 seconds to enter Setup mode. Select the Outputs menu, and then select:

- # Stages = 3 (T775 assigns pump to Relay 4)
- Options → Reset = YES-BOILER
- Options → On Delay and Off Delay: Seconds = 0 to 3,600 (default is 0)
- Options → WWSD = YES or NO Temperature = 30 to 100° F (-1 to 38° C)
- STG4/Pump: (Relay 4 controls the pump output)¹ Enable = YES Exercise = YES or NO Prepurge = -300 to 300 seconds (default is 0) Postpurge = 0 to 300 seconds (default is 0)

Return to the Setup menu, and select Alarms:

- High Alarm = YES
- High Limit = 220° F (104° C)

Stages 1-3: Control to the discharge water temperature

Program for: (Refer to the reset curve in Fig. 21.)

- Boiler Max = 210° F (99° C)
- Outside Min = 20° F (-7° C)
- Boiler Min = 160° F (71° C)
- Outside Max = 70° F (21° C)
- Throttling Range = 18° F (-8° C)
- Sensor A
- Heat
- Setback = -10° F (-12° C) (Optional)

¹See Notes in "Programming Example" on page 18 for an explanation of Prepurge and Postpurge times.

IMPORTANT

After the desired value is selected, be sure to press the ◀ or ▶ or HOME button in order to save that value in the controller's memory.

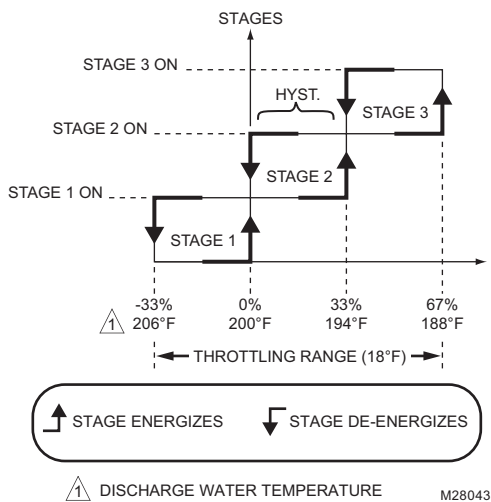

Fig. 20. Boiler control staging behavior (when effective setpoint = 200° F).

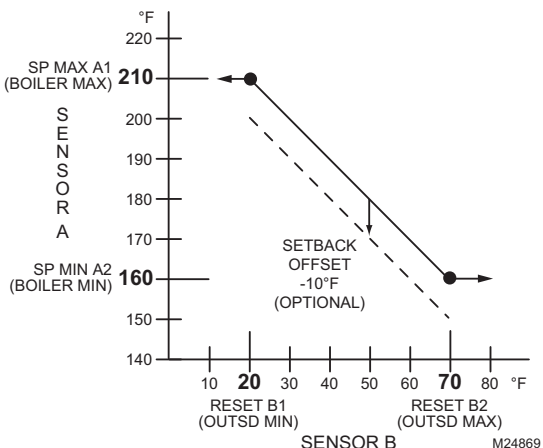

Fig. 21. Reset curve with optional setback offset.

Wiring

All output relays should have a common power wiring source, which may or may not be the same as the T775 power wiring. See Fig. 22.

NOTE: The Multi-Stage Boiler Control (Reset) application continues on the next page.

Multi-Stage Boiler Control (Reset) (continued)

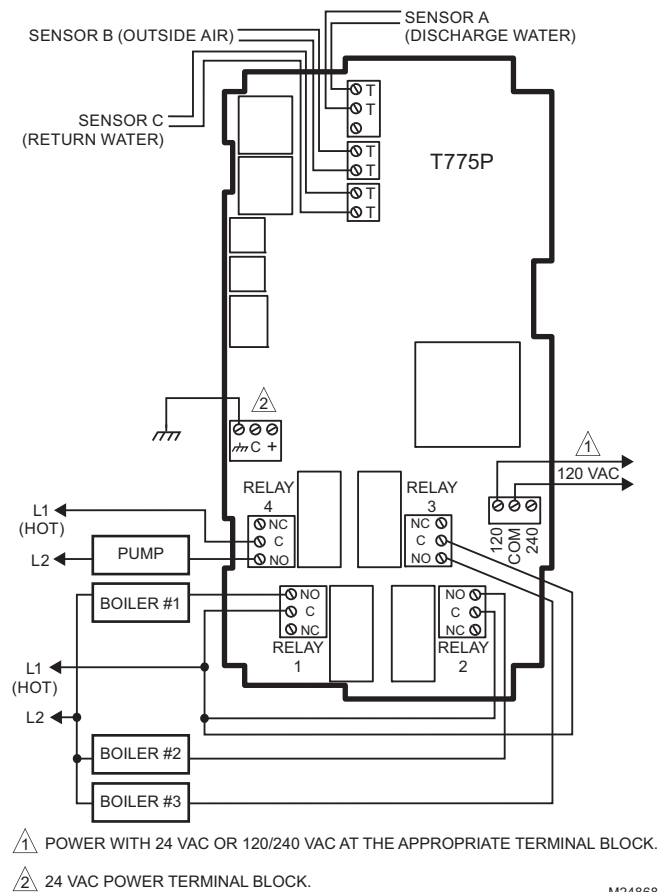

Fig. 22. T775P wiring — multi-stage boiler control with reset.

Multi-Stage Chiller Control (No Reset) – T775P

Application Description

The T775P is providing multistage cooling control based on the chiller's discharge water temperature. The T775P uses the fourth output relay to energize the primary pump.

Any number of stages from 1 to 12 can be configured (T775P and T775L models). The throttling range is divided equally among the stages.

Sensor Designation

This device application requires three sensors.

- Sensor A is sensing chiller discharge water and is used to control 3 chiller stages.
- Sensor B is sensing outside temperature and is used to control Relay 4, the pump output.
- Sensor C is sensing the chiller return water temperature.

NOTE: Control can be to either Sensor A or C.

Operation

In this 3-stage example, as the cooling load increases, additional stages of cooling will cycle ON as the chiller water temperature increases. The T775P will stage three chillers to provide sufficient cooling. See Fig. 23 for staging behavior.

The primary circulating pump energizes whenever any stage is energized.

Programming Example

Program in Setup:

Press and hold the **MENU** button for 5 seconds to enter Setup mode. Select the Outputs menu, and then select:

- # Stages = 3 (T775 assigns pump to Relay 4)
- Options → On Delay and Off Delay:
Seconds = 0 to 3,600 (default is 0)
- STG4/Pump: (Relay 4 controls the pump output)¹
Enable = YES
Exercise = YES or NO
Prepurge = -300 to 300 seconds (default is 0)
Postpurge = 0 to 300 seconds (default is 0)

Return to the Setup menu, and select Alarms:

- Low Alarm = YES
- Low Limit = 54° F (12° C)

Stages 1-3: Control to the discharge water temperature

Program for:

- Setpoint = 72° F (22° C)
- Throttling Range = 12° F (-11° C)
- Sensor A
- Cool

IMPORTANT

After the desired value is selected, be sure to press the ◀ or ▶ or HOME button in order to save that value in the controller's memory.

¹ See Notes in See "Programming Example" on page 17. for an explanation of Prepurge and Postpurge times.

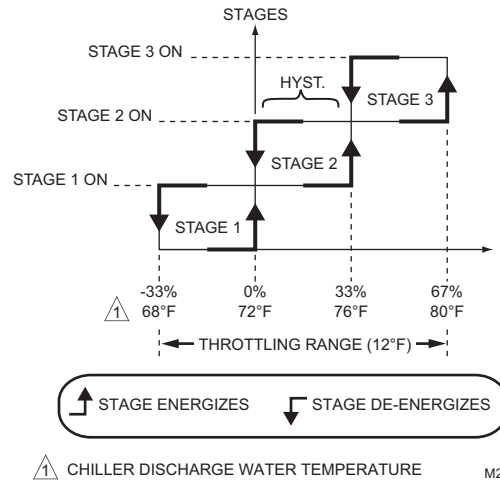

Fig. 23. Chiller control staging behavior (when the effective setpoint = 72° F).

Wiring

All output relays should have a common power wiring source, which may or may not be the same as the T775 power wiring. See Fig. 24.

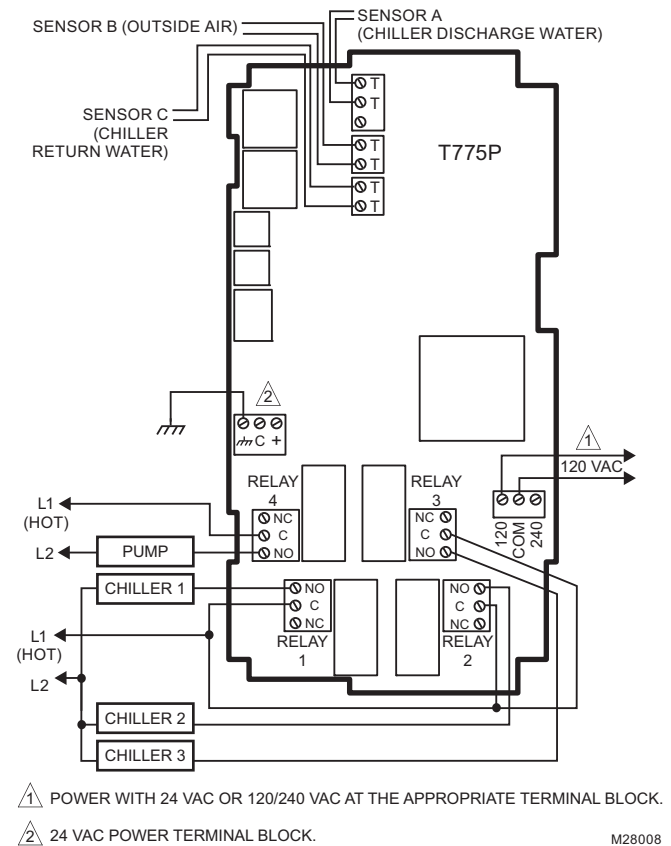

Fig. 24. T775P wiring — multi-stage chiller control (no reset).

4 Stage with Pump Output and Reset – T775P using a T775S Expansion Module

Application Description

The T775P is providing multistage boiler control based on the boiler's discharge water temperature. Four stages and a dedicated pump output are used in this example. The T775P uses the eighth output relay to energize the primary pump.

NOTE: The pump output is always the last relay output. In this application example, four relays are used for staged boiler control. A T775S expansion module is added to provide the additional relay for the pump. However, the pump must be the last relay, so it is configured as Relay 8 on the T775S module.

Any number of stages from 1 to 12 can be configured (T775P and T775L models). The throttling range is divided equally among the stages.

Sensor Designation

This device application requires three sensors.

- Sensor A is sensing discharge water and controls 4 stages.
- Sensor B is sensing outside temperature and is used for reset.
- Sensor C is sensing the return water temperature.

NOTE: Control can be to either Sensor A or C.

Operation

As the heating load increases additional stages of heat will cycle ON as the boiler water temperature decreases. In this example, the T775P provides four stage control when the effective setpoint is 200° F (93° C). (See Fig. 25.) The primary circulating pump energizes whenever any stage is energized.

NOTE: The pump output must always be the last relay on the controller or expansion module (Relay 4, 8, or 12).

NOTE: For applications with 3 stages or less with a pump output, an additional expansion module is not needed.

Programming Example

Program in Setup:

- Press and hold the **MENU** button for 5 seconds to enter Setup mode. Select the Outputs menu, and then select:
 - # Stages = 4 (T775 assigns pump to Relay 8)
 - Options → Reset = YES-BOILER
 - STG8/Pump: (Relay 8 controls the pump output)¹
 - Enable = YES
 - Exercise = YES or NO
 - Prepurge = -300 to 300 seconds (default is 0)
 - Postpurge = 0 to 300 seconds (default is 0)

Stages 1-4: Control to the discharge water temperature

Program for: (Refer to the reset curve in Fig. 26.)

- Boiler Max = 210° F (99° C)
- Outside Min = 20° F (-7° C)
- Boiler Min = 160° F (71° C)
- Outside Max = 70° F (21° C)
- Throttling Range= 20° F (-7° C)
- Sensor A
- Heat

¹ See Notes in “Programming Example” on page 18 for an explanation of Prepurge and Postpurge times.

IMPORTANT

After the desired value is selected, be sure to press the ◀ or ▶ or HOME button in order to save that value in the controller's memory.

IMPORTANT

By programming the boiler setpoint at 210° F (-99° C) the T775 has established 210° F (-99° C) as the highest operating point that will be allowed when the temperature falls below 20° F (-7° C). As temperature increases above 20° F (-7° C), the boiler will be reset downward per the reset ratio until it reaches the minimum setpoint of 160° F (-99° C), at 70° F (21° C) and above outdoor temperature.

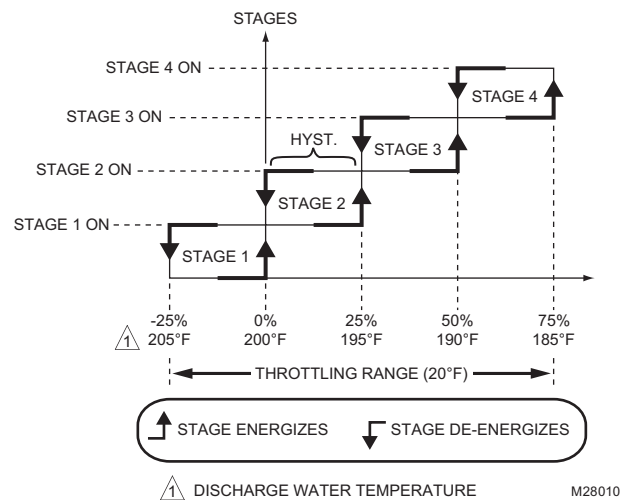

Fig. 25. Staging behavior (when the effective setpoint = 200° F (93° C))

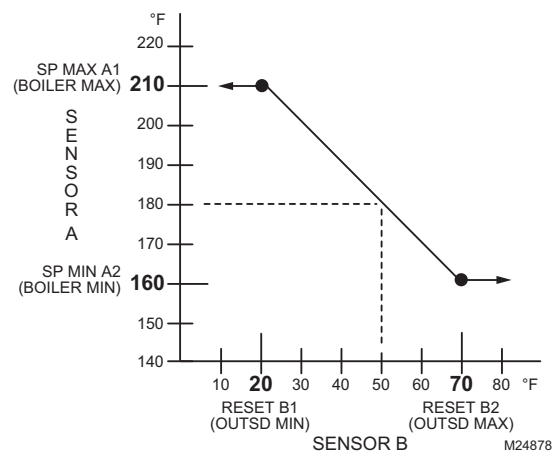

Fig. 26. Reset curve.

NOTE: The 4 stage with pump output and reset application continues below.

4 Stage with Pump Output and Reset (continued)

Wiring

All output relays should have a common power wiring source, which may or may not be the same as the T775 power wiring. See Fig. 27.

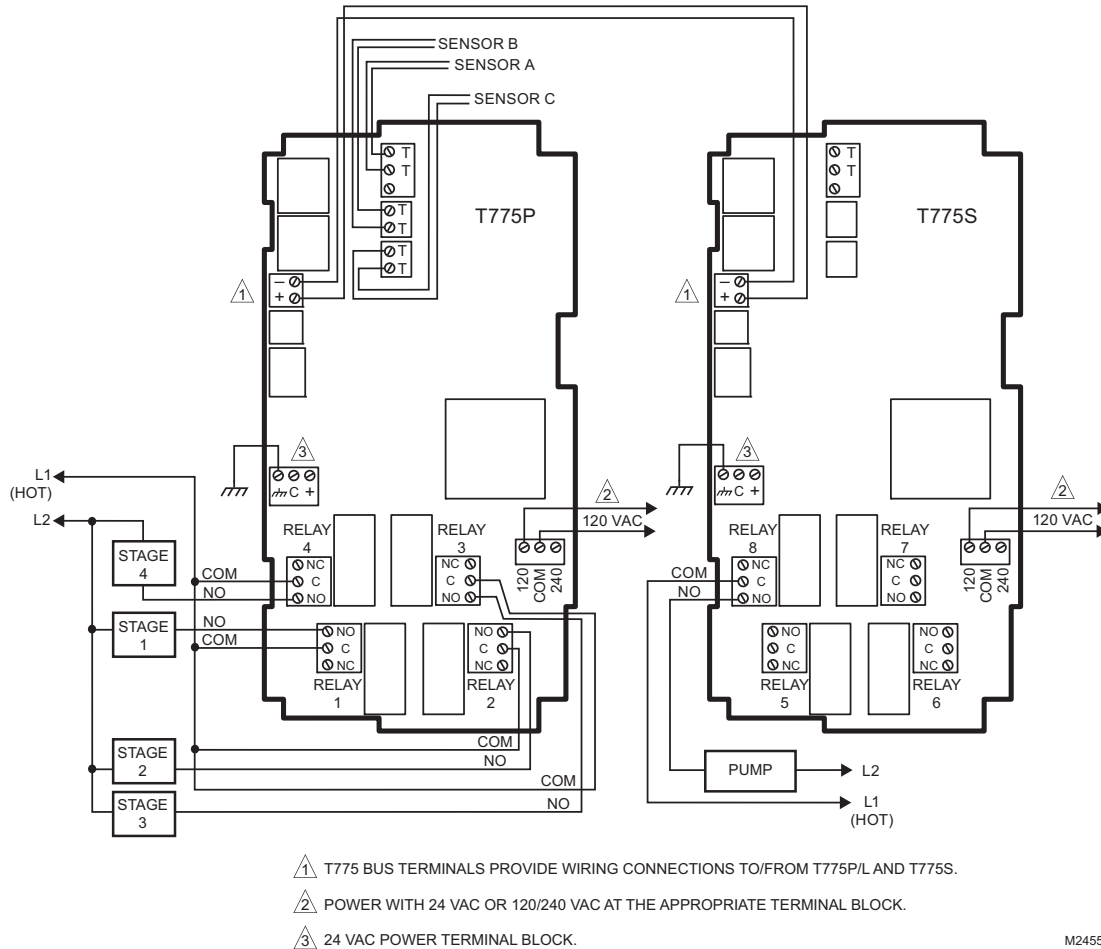

Fig. 27. T775P wiring — 4 stage with pump output and reset.

Device Checkout

The T775 performance can be checked out to determine if proper operation exists.

For example, when the outside air temperature is at 50° F (10° C), the boiler temperature should be 180° F (22° C). See Fig. 28. Use the alternate Home screen to check that the effective setpoint is adjusting correctly based on the outside air temperature (Sensor B).

NOTE: The alternate Home screen does not show live updates of the sensor temperature. It shows the temperature only at the moment the button is pressed.

1. From the Home screen, use the ► button to verify the setpoint temperature for each output.
2. Then, press the **HOME** button to view the actual outside air temperature (Sensor B).

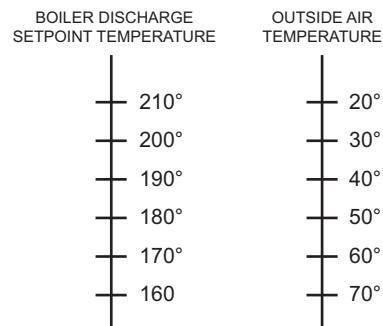

Fig. 28. Boiler discharge temperature vs. outside temperature.

3 Stage Reciprocating Chiller – T775L

Application Description

The T775L is controlling the return water in a reciprocating chiller with fast-dump freeze protection, low temperature cutoff, and optional low pressure cutoff.

Sensor Designation

This device application requires two sensors.

- Sensor A is sensing return water and controlling three stages of cooling.
- Sensor B is sensing discharge water and is controlling Relay 4 for freeze protection.

Operation

Return water is one indication of the cooling load in the water loop. For example, the higher the return water temperature the higher the apparent load and more stages of refrigeration or cooling would be required. If a large load is quickly dropped from the loop, or for some reason water flow through the chiller is reduced, discharge water temperature may drop rapidly to freezing conditions. In this example, Sensor B in the discharge water will prevent damage to the system by *fast-dumping* all cooling stages upon close-to-freezing conditions.

Programming Example

Program in Setup:

- Press and hold the **MENU** button for 5 seconds to enter Setup mode. Select the Outputs menu, and then select:
 - # Relays = 3
 - # Loops = 1
 - Options → DI Options = Disable (acts as low pressure cutoff)
 - Loop 1 → # Relays = 3
 - Loop 1 → Reset = NO

Loop 1: Chiller cooling

Program for:

- Setpoint = 62° F (17° C)
- Throttling Range = 12° F (-11° C)
- Sensor A
- Cool

Relay 4: Low temperature cutoff for freeze protection

Program for:

- Setpoint = 40° F (4° C)
- Differential = 4° F (-16° C)
- Sensor B
- Heat

IMPORTANT

After the desired value is selected, be sure to press the ◀ or ▶ or HOME button in order to save that value in the controller's memory.

Wiring

All output relays should have a common power wiring source, which may or may not be the same as the T775 power wiring. See Fig. 29.

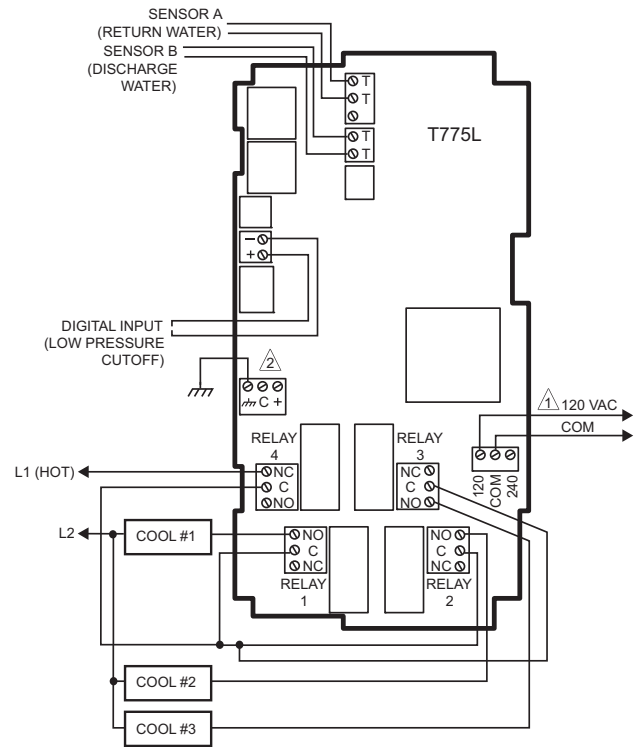

▲ 1 POWER WITH 24 VAC OR 120/240 VAC AT THE APPROPRIATE TERMINAL BLOCK.
▲ 2 24 VAC POWER TERMINAL BLOCK. M25514

Fig. 29. T775L wiring — reciprocating chiller.

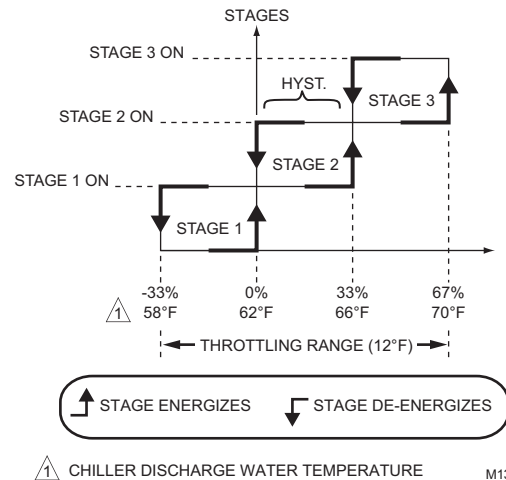

▲ 1 CHILLER DISCHARGE WATER TEMPERATURE M13895
Fig. 30. Chiller control staging behavior (when the effective setpoint = 62° F (17° C)).

4 Stage Heat and 6 Stage Cool – T775L

Application Description

The T775L is providing control for four boilers based on the boiler's discharge water temperature and providing multistage cooling control.

NOTE: The T775L (with up to two expansion modules) can control any number of heating and cooling stages up to a maximum of 12 stages.

Sensor Designation

This device application requires two sensors.

- Sensor A is sensing boiler discharge water temperature for staged heating control.
- Sensor B is used for cooling control.

Operation

In this example, as the heating load increases, additional stages of heat will cycle ON as the temperature decreases at Sensor A. The T775L will use four stages to provide sufficient heating. The six cooling stages are controlled by Sensor B.

NOTES:

1. The Interstage ON and OFF delay is an option for both the heating and the cooling loops.
2. Because only 10 of the 12 relays are being used, the remaining two relays can be used as independent controls, each with its own setpoint and throttling range.

Programming Example

Program in Setup:

Press and hold the **MENU** button for 5 seconds to enter Setup mode. Select the Outputs menu, and then select:

- # Relays = 10 (4 heat and 6 cool)
- # Loops = 2
- Loop 1 → # Relays = 4
- Loop 1 → Reset = NO¹
- Loop 2 → # Relays = 6
- Loop 2 → Reset = NO

NOTES:

1. The Integral setup parameter can be left at the factory default setting or adjusted as needed for each loop.
2. The On Delay and Off Delay setup parameters can be adjusted according to the application.

Loop 1: Control to Sensor A

Program for:

- Setpoint = 200° F (93° C)
- Throttling Range = 20° F (-7° C)
- Sensor A
- Heat
- Relays = 1-4

¹ Reset can be used for the T775L. However, keep in mind that only one reset curve can be programmed. This means that you can offset from the curve, but you cannot create a second reset curve. Normally reset curves can be used for Heat or Cool, not both.

Loop 2: Control to Sensor B

Program for:

- Setpoint = 72° F (22° C)
- Throttling Range = 12° F (-11° C)
- Sensor B
- Cool
- Relays = 5-10

IMPORTANT

After the desired value is selected, be sure to press the ◀ or ▶ or HOME button in order to save that value in the controller's memory.

Wiring

All output relays should have a common power wiring source, which may or may not be the same as the T775 power wiring. See Fig. 31.

NOTE: The 4 Stage Heat and 6 Stage Cool application continues on the next page.

4 Stage Heat and 6 Stage Cool (continued)

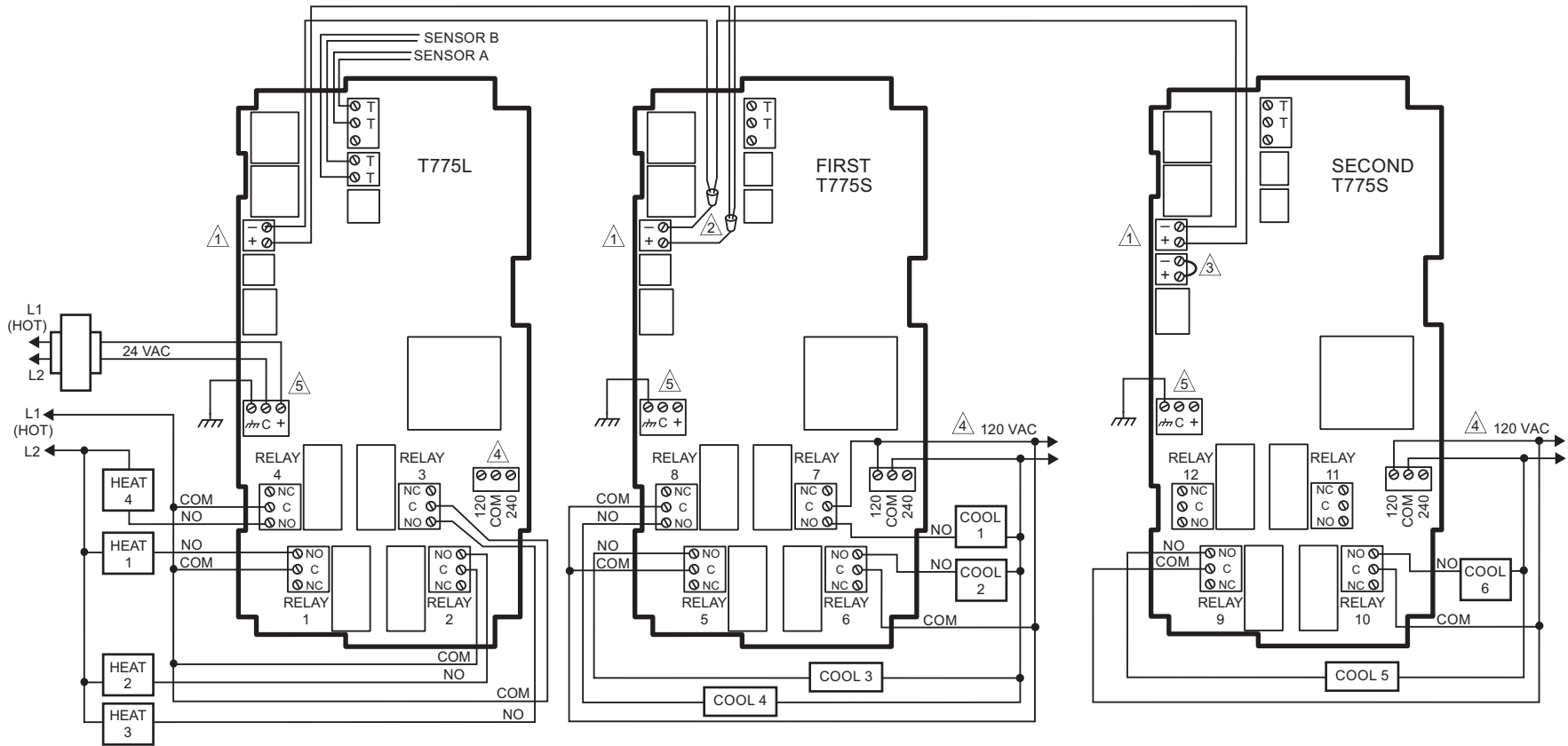

- ① T775 BUS TERMINALS PROVIDE WIRING CONNECTIONS TO/FROM T775L AND T775S.
- ② USE PIGTAIL CONNECTIONS TO WIRE THE T775 BUS TERMINALS ON THE FIRST T775S
- ③ SECOND T775S MUST HAVE A JUMPER INSTALLED AS SHOWN AT THE JUMPER TERMINAL.
- ④ POWER WITH 24 VAC OR 120/240 VAC AT THE APPROPRIATE TERMINAL BLOCK.
- ⑤ 24 VAC POWER TERMINAL BLOCK.

Fig. 31. T775L wiring — 4 stage heat and 6 stage cool using 2 loops.

Pressure with a Variable Frequency Drive (VFD) – T775U

Application Description

In this application the T775U is controlling duct pressure with a fan controlled by an NXS or NXL Variable Frequency Drive. A P7640 pressure sensor, located in the duct, is providing sensor input to the T775U to control the fan speed. The VFD is looking for a 4-20 mA PID control signal from the T775U and will drive the fan with a signal directly proportional to this T775U output.

For additional information about the NXS or NXL variable frequency drives (VFD), refer to the *VFD Reference Guide*, form 63-9469.

Sensor Designation

This device application requires one sensor.

- Sensor A is sensing pressure at the duct (reference is at the room).

Operation

In this example, as the sensed pressure decreases, the fan speed increases. Assume we have a 0-10 Vdc sensor output for 0-5 inches water column. First, set up a Sensor type of 0-10 Vdc into the T775U Sensor A settings, and a minimum (0) and maximum (5) inches water column for the sensor range.

Also set up a 4-20 mA PID modulating output loop (MOD 1) at the T775U with a setpoint of 2.5 inches and a throttling range of 2 inches, and a reverse acting action. At a sensed pressure of 2.5 inches (in other word, at setpoint), MOD 1 will output close to 50% or about 12 mA. At 1.5 inches water column, the output will be 100% or about 20 mA, and at 3.5 inches water column, the output will be 0% or about 4 mA. Keep in mind these values are valid for proportional control and will differ in a PID loop where integral (usually desired) and derivative (less often required) are set to non-zero values.

Integral and derivative time may need to be adjusted, along with the throttling range.

Programming Example

Program in Setup:

Press and hold the **MENU** button for 5 seconds to enter Setup mode, and then select:

- Sensors → Sensor A:
 - Type = 0-10V
 - Units = IN WC
 - Minimum Value = 0.0
 - Maximum Value = 5.0
- Outputs → MOD 1 (Modulating Output):
 - Type = 4-20 mA

Program MOD 1 for:

- Setpoint = 2.5
- Throttling Range = 2 inches w.c.
- Action = REV ACT

IMPORTANT

After the desired value is selected, be sure to press the ◀ or ▶ or HOME button in order to save that value in the controller's memory.

IMPORTANT

After programming the VFD, be sure to check the following:

1. Verify that the VFD value P7.1.1.2 (AI2 mode) is set to 2 (4-20 mA).
2. Verify that the jumper block X2 on the Expansion board A is in Current Input Mode (a jumper is across the A terminals, and a jumper is across the B terminals).
3. Verify that the P7640A pressure sensor is set to:
 - Output = Voltage
 - Range = 0 to 5 inches w.c.
 - Mode = Unidirectional (default)
 - Volt = 10 Vdc

Wiring

See Fig. 32 for wiring connections for the T775U, the pressure sensor, and the Variable Frequency Drive.

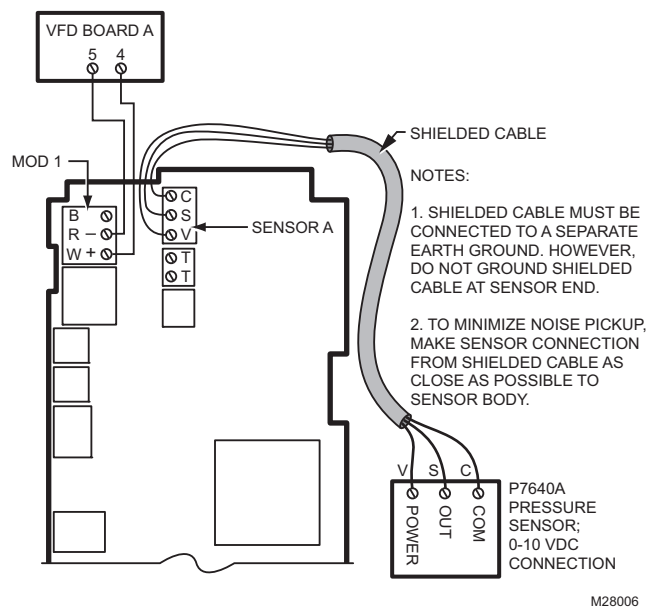

Fig. 32. T775U wiring — pressure with a VFD (loop powered wiring).

Carbon Dioxide (CO₂) Sensing – T775U

Application Description

In this application, the T775U is controlling an outside air damper based on CO₂ sensing input, to maintain reasonable CO₂ levels.

Sensor Designation

This device application requires one sensor.

- Sensor A is sensing CO₂ in parts per million

Operation

In this example, as the CO₂ level increases a damper is opened to allow fresh air to enter the facility.

Many CO₂ sensors are used with a 0-2,000 ppm output range. Parts per million (ppm) units not available on the T775U.

- Set the units for Ppm and enter 0 for a minimum and 2,000 for a maximum. The controller will simply convert the input signal (0-10 Vdc or 4-20 mA) into the correct ppm value and display it on the screen.

Programming Example

Program in Setup:

Press and hold the **MENU** button for 5 seconds to enter Setup mode, and then select:

- Sensors → Sensor A:
 - Type = 0-10V
 - Units = PPM
 - Minimum Value = 0.0
 - Maximum Value = 2000

NOTE: Sensor A is a 0-10 Vdc CO₂ sensor (C7232) with a range of 0 to 2,000 PPM

IMPORTANT

After the desired value is selected, be sure to press the ◀ or ▶ or HOME button in order to save that value in the controller's memory.

Wiring

See Fig. 33 for wiring connections for the T775U and the CO₂ sensor.

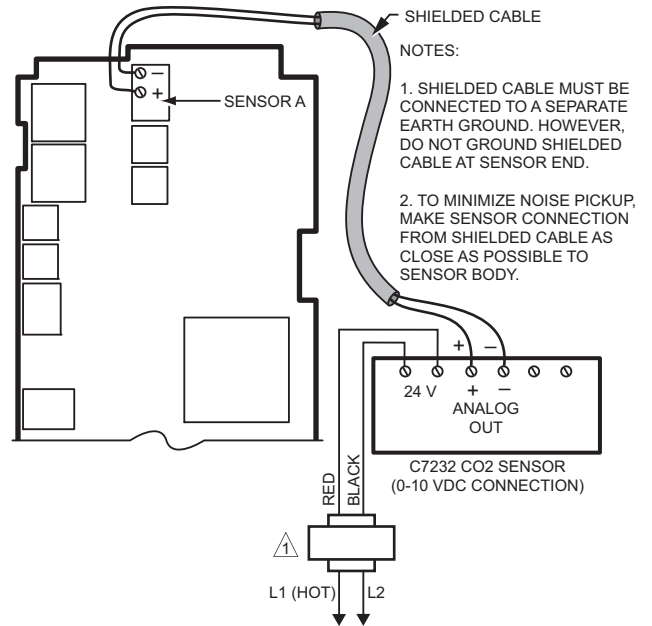

⚠ USE SEPARATE 24 V TRANSFORMER TO POWER THE C7232 CO2 SENSOR. PROVIDE DISCONNECT MEANS AND OVERLOAD PROTECTION AS REQUIRED.

M24882

Fig. 33. T775U wiring — carbon dioxide sensing control.

Resetting Zone Air Temp Based on Outside Air Temp (2 stage cooling)

Application Description

In this example, the T775L provides two stage DX cooling based on zone temperature. The T775L calculates the zone air temperature setpoint based on the actual outside air temperature using a reset curve.

Sensor Description

This device application requires two sensors.

- Sensor A is sensing zone air temperature.
- Sensor B is sensing outside air temperature.

Operation

When the outdoor air temperature reaches 90 ° F the desired zone air temp is 75 ° F, Likewise when the outside air temp drops to 50 ° F the zone temp needs to be 68 ° F.

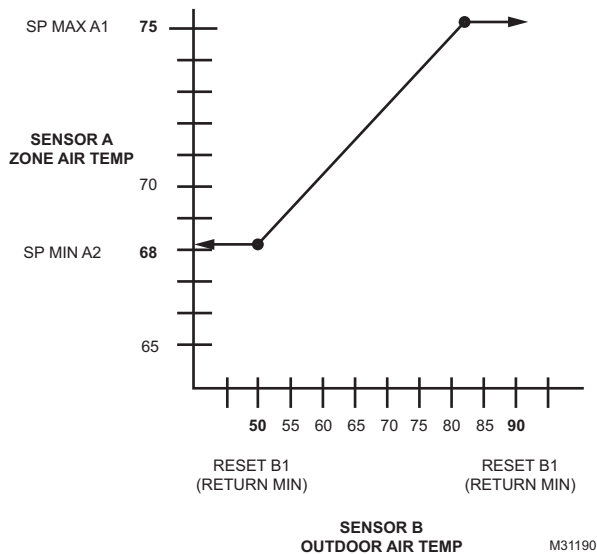

Fig. 34. Zone air reset curve

Programming Example

Program in Setup:

Press and hold the MENU button for 5 seconds to enter Setup mode. Select the Outputs menu, and then select:

```
# RELAYS = 2
# LOOPS = 1
LOOP 1 → # RELAYS = 2
LOOP 1 → RESET = YES-OTHER
```

LOOP 1 Program for: (Refer to the reset curve in Figure 34)

- Setpoint Max A1 (Zone Max) = 75° F (24° C)
- Reset B1 (Outside Min) = 50° F (10° C)
- Setpoint Min A2 (Zone Min) = 68° F (20° C)
- Reset B2 (Outside Max) = 90° F (32° C)
- Differential = 20° F (-7° C)
- Cool.

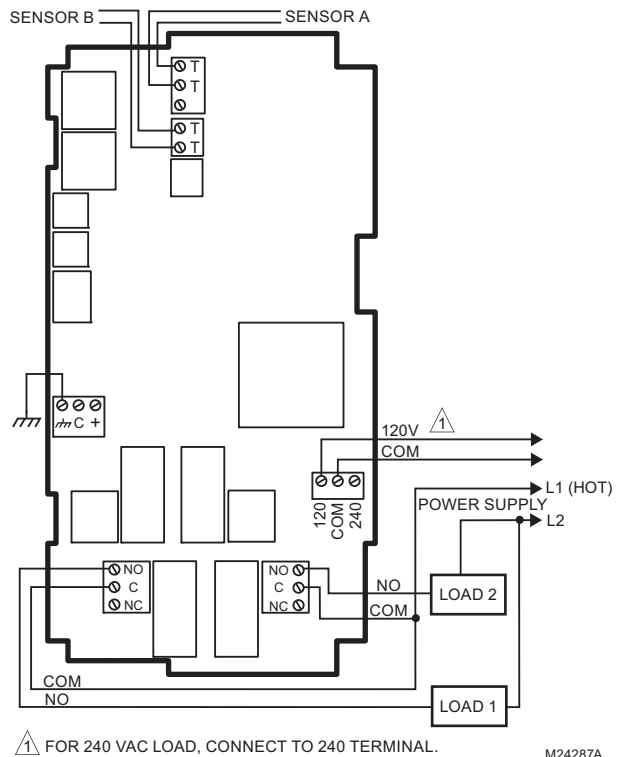

Fig. 35. T775 wiring — 2 stage cooling

Resetting Discharge Air Temp Based on Return Air Temp (Modulating cooling valve)

Application Description

The T775R is controlling discharge air temperature based on return air temp using a reset curve.

The T775R calculates the discharge temp setpoint based on the actual return temp in the air handling unit.

Sensor Description

- This device application requires two sensors:
- Sensor A is sensing discharge air temperature.
 - Sensor B is sensing return air temperature.

Operation

In this example, the T775R controls an actuator, based on the discharge temperature setpoint to modulate the cool water valve.

When the return air temperature reaches 75, the desired discharge air temp is 50. Likewise when the return air temp drops to 70, the discharge temp needs to be 60.

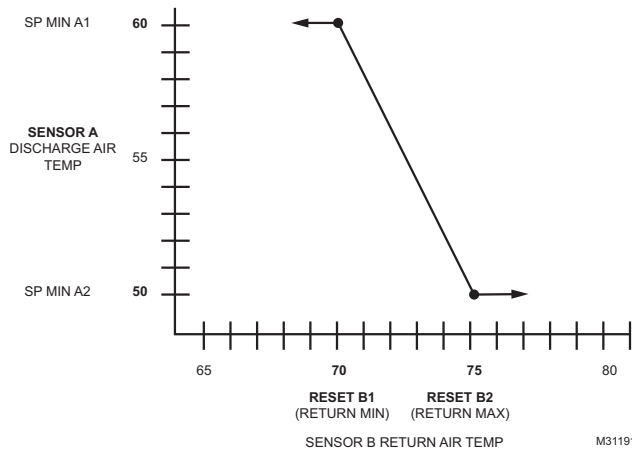

Fig. 36. Discharge air reset curve

Programming Example

Program in Setup:

Press and hold the MENU button for 5 seconds to enter Setup mode. Select the Outputs menu, and then select:

MOD 1 → RESET = YES-OTHER

MOD1 Program for: (Refer to the reset curve in Figure 36)

- Setpoint Max A1 (Discharge Max) = 60° F (16° C)
- Reset B1 (Return Min) = 70° F (21° C)
- Setpoint Min A2 (Discharge Min) = 50° F (10° C)
- Reset B2 (Return Max) = 75° F (24° C)
- Throttling Range = 10° F (-12° C)
- Cool.

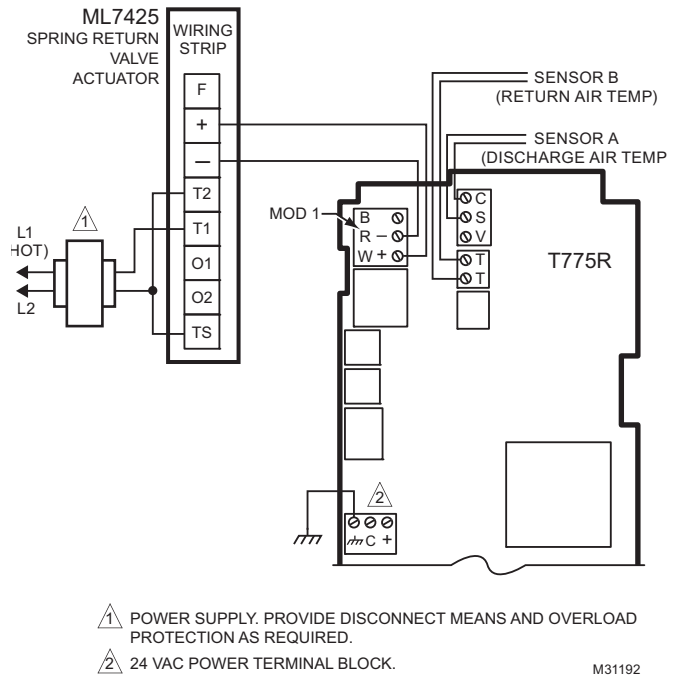

- 1 POWER SUPPLY. PROVIDE DISCONNECT MEANS AND OVERLOAD PROTECTION AS REQUIRED.
- 2 24 VAC POWER TERMINAL BLOCK.

M31192

Fig. 37. T775 wiring — valve modulation

Using the T775R as a Differential Temperature Controller for Solar Water Heating

Application Description

The T775 can be used as a differential temperature controller for solar water heating applications. The controller regulates the circulation of water between the solar energy collector and the water storage tank. The circulation pump turns on/off based on the desired (predetermined) temperature differential between the collector and the tank.

Sensor Description

This device application requires two sensors:

- Sensor A is sensing collector water temperature.
- Sensor B is sensing storage water temperature.

Operation

Programming example: Settings may be changed according to geographical location, equipment, and other preferences.

Pump turns on when there is a 25°F differential between the solar collector water temperature and the storage tank temperature and turns off when the differential is 5°F.

High limit shut off or alarm at 190°F.

Optional low temperature purge or alarm at 40°F.

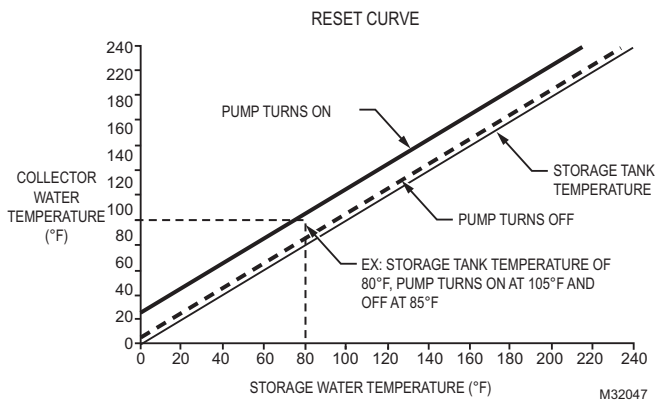

Fig. 38. Reset curve.

Programming Example

Program in Setup:

Press and hold the MENU button for 5 seconds to enter Setup mode. Select the Outputs menu, and then select:

Setting up the Sensor label names (Optional).

SETUP→SENSORS→SENSOR A

Select Label then highlight DISCHRG A. Press the ◀ once to get back to the SENSORS menu. Select SENSOR B.

Select Label then highlight RETURN B. Choose other names if desired.

Setting up RELAY 1 and RELAY 2 for reset.

SETUP → OUTPUTS

RELAY 1 → RESET = YES-OTHER (used only to set the differential curve, do not wire Relay 1)

RELAY 2 → RESET = YES

RELAY 3 → RESET = YES

Press Home to exit Setup, and press Menu to enter programming.

RELAY 1: The below settings for RELAY 1 are to establish the offset curve only. There will not be any electrical connections to RELAY 1. (Refer to reset curve in Fig. 38).

SP MAX A1 = 248°F

RESET B1 = 248°F

SP MIN A2 = -40°F

RESET B2 = -40°F

DIFFRENTL = N/A

HEAT/COOL = HEAT

RELAY 2: Enter the temperature differential at which you want the pump to turn on. In our example this value is 25°F.

- OFFSET = 25°F

Next you must determine the value at which you want the pump to shut off. The differential will determine the number of degrees below the setpoint (25°F differential) at which the pump will turn off. In our example this value is 20°F (i.e., 5°F above the storage tank temperature).

- DIFFRNTL = 20°F

- HEAT

RELAY 3: Enter the high limit temperature. The pump will shut off if the return water temperature from the storage tank reaches this temperature. In our example this value is 190°F.

- SETPOINT = 190°F

- DIFFRRTL = 5°F

- SENSOR: SENSOR B

- HEAT

RELAY 4: Enter the low limit temperature. An alarm will turn on or valve will close when the return water from the storage tank reaches this temperature. In our example this value is 40°F.

- SETPOINT = 40°F

- DIFFRRTL = 2°F

- SENSOR: SENSOR B

- HEAT

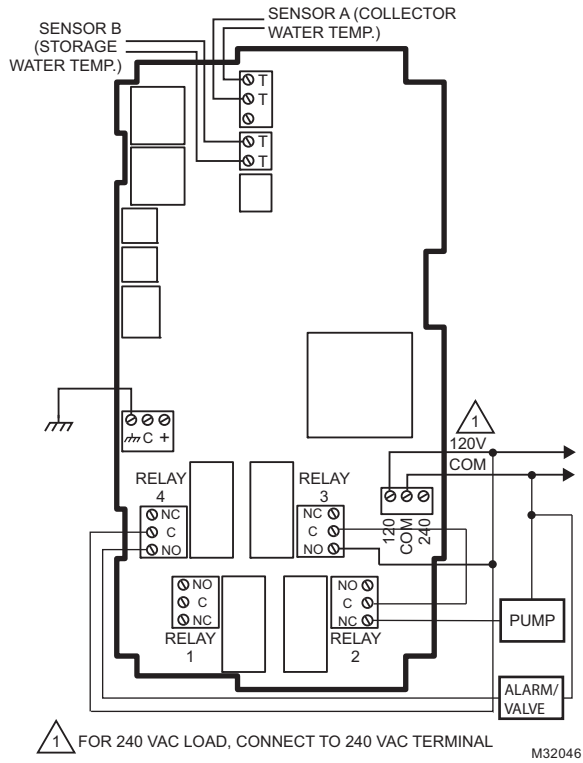

Fig. 39. T775R wiring diagram for solar water heating.

Maintaining Differential Temperature for both Heating and Cooling

Application Description

This T775 program can be used to maintain a differential temperature between Sensor A and Sensor B. This is done by using the T775R2001, which can be used to maintain a delta temperature between the sensors.

Sensor Description

- This device application requires two sensors.
- Sensor A is sensing room temperature.
 - Sensor B is sensing outside air temperature.

Operation

In this example, the T775 program energizes dampers to open for free cooling or free heating. One relay energizes for cooling whenever the outside temperature (Sensor B) is at least 3°F above the room temperature (Sensor A), and de-energizes when the temperature drops to 1°F above the room temperature. A second relay energizes for heating when temperature is at least 3°F below the room temperature and turns off when temp rises to 1°F below the room temperature.

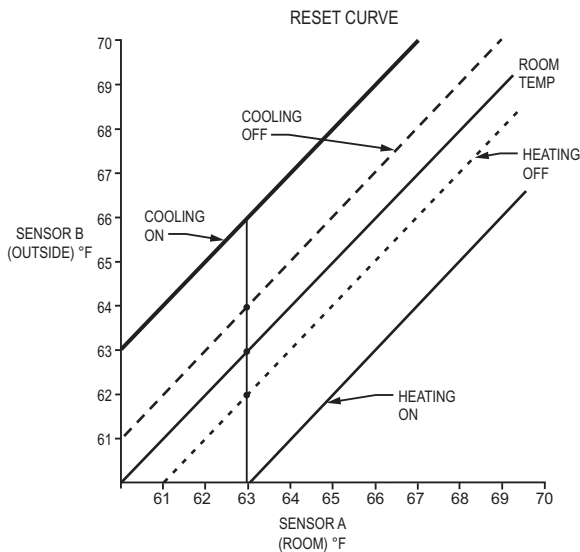

EXAMPLE: ROOM TEMPERATURE IS 63°F. COOLING TURNS ON WHEN TEMP RISES TO 66°F AND TURNS OFF WHEN TEMP FALLS TO 64°F. HEATING TURNS ON WHEN TEMP FALLS TO 60°F AND TURNS OFF WHEN TEMP RISES TO 62°F.

M32048

Fig. 40. Reset curve.

Programming Example

Program in Setup:

Press and hold the MENU button for 5 seconds to enter Setup mode. Select the Outputs menu, and then select:

Setting up the Sensor label names (Optional).

SETUP → SENSORS → SENSOR A

Select Label, then highlight ROOM A. Press ◀ once to get back to the SENSORS menu. Select SENSOR B. Select Label then highlight OUTDOOR B. Choose other names if desired.

Setting up RELAY 1 and RELAY 2 for reset.

SETUP → OUTPUTS

RELAY 1 → RESET = YES-OTHER (used only to set the differential curve, do not wire Relay 1)

RELAY 2 → RESET = YES (used for cooling)

RELAY 3 → RESET = YES (used for heating)

Press Home to exit Setup, and press Menu to enter programming.

RELAY 1: The below settings for RELAY 1 are to establish the reset curve only. There will not be any electrical connections to RELAY 1. (Refer to reset curve in Fig. 40).

SP MAX A1 = 248°F

RESET B1 = 248°F

SP MIN A2 = -40°F

RESET B2 = -40°F

DIFFRENTL = N/A

HEAT/COOL = HEAT

RELAY 2: Enter the temperature delta (difference) at which you want the cooling to turn on. In our example this value is 3°F above the room temperature.

OFFSET= 3°F

Next, the differential will determine the number of degrees below the setpoint (3°F differential) at which the cooling will turn off. In our example this value is 2°F

(i.e., 1°F above the room temperature).

DIFFRNTL = 2°F

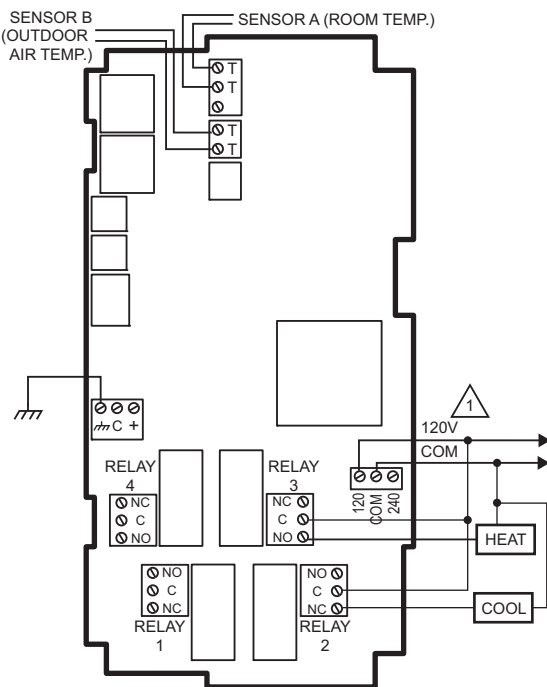

△ FOR 240 VAC LOAD, CONNECT TO 240 VAC TERMINAL. M32045

Fig. 41. T775R wiring diagram for maintaining differential temperature for both heating and cooling.

T775 APPLICATION REPLACEMENT EXAMPLES

This section describes how a T775 Series 2000 Electronic Stand-Alone Controller is wired and programmed to replace various older generation Honeywell devices.

T775M2030 Replacement for W973A Logic Panel

This replacement example illustrates how a T775M2030 is configured to replace a two-stage Heat and two-stage Cool W973A Logic Panel.

- Fig. 42 illustrates the wiring connections for the W973A Logic Panel.
- Fig. 43 and Table 2 on page 35 illustrate the wiring and configuration of the T775M2030 controller.

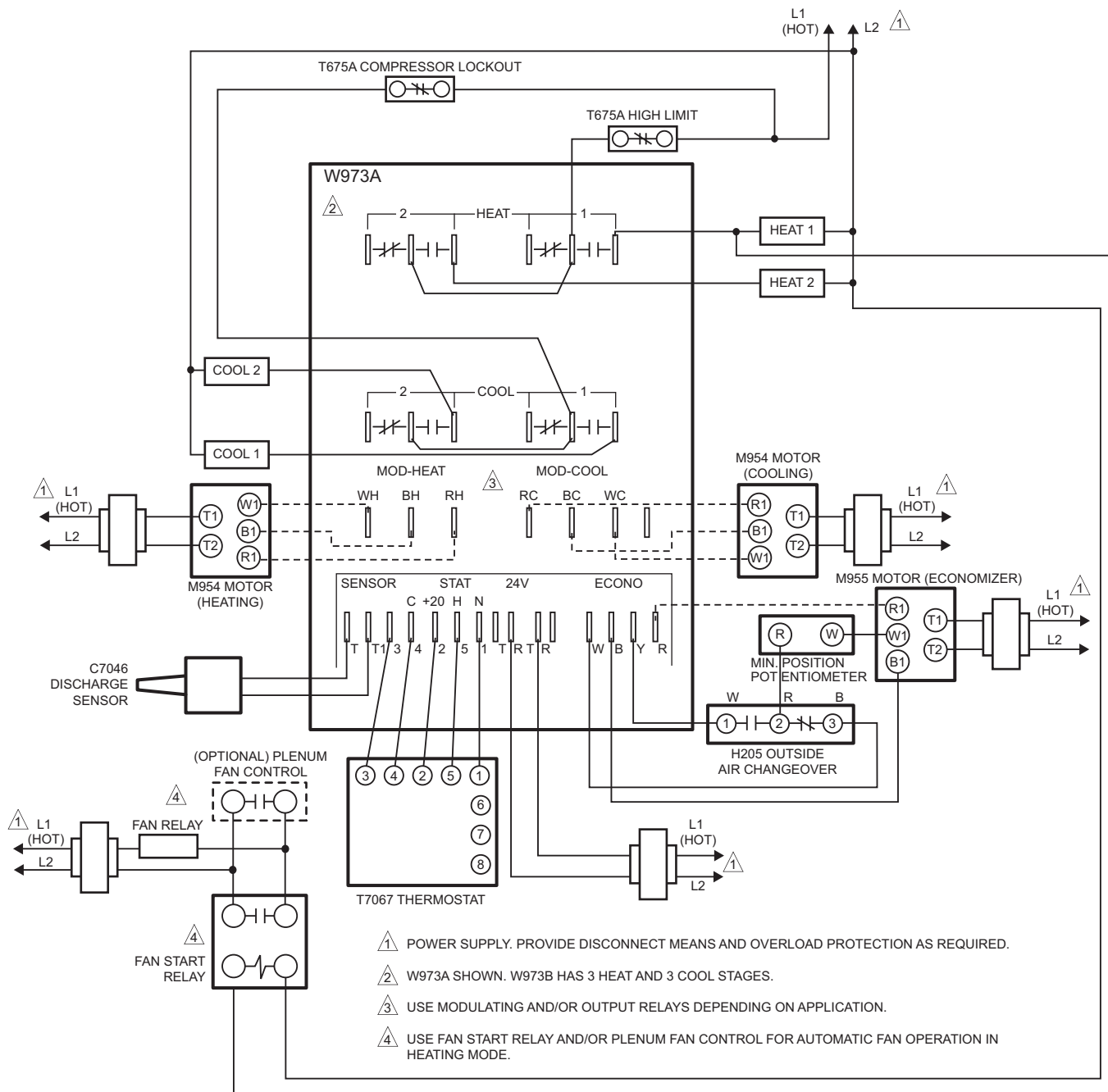

M24562

Fig. 42. W973A wiring connections (pre-existing control).

NOTE: The T775M2030 Replacement for W973A Logic Panel continues on the next page.

T775M2030 Replacement for W973A Logic Panel (continued)

NOTE: Fig. 43 is for wiring purposes only. A thorough review of the existing W973A application is required in order to determine the capability of the T775 controller replacement.

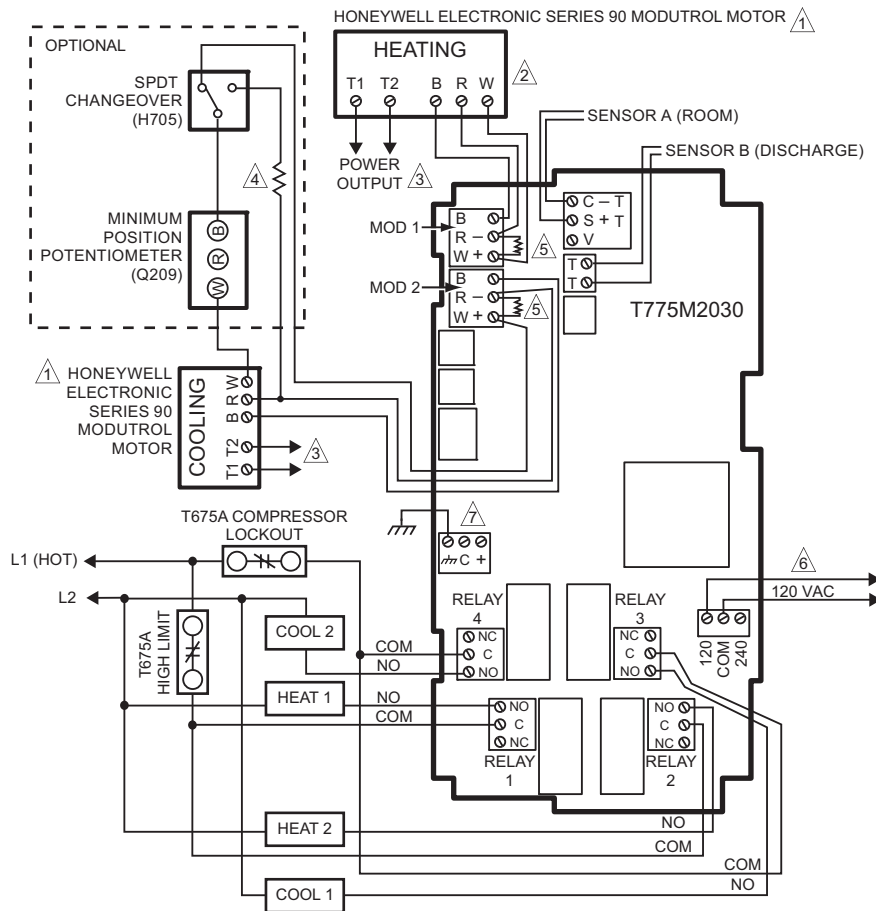

- 1 OTHER MOTORS SUCH AS 4-20 MA, 0-10 VDC, AND 2-10 VDC, MAY BE USED.
- 2 TO VERIFY OUTPUT, TEST OPEN CIRCUIT VOLTAGE BETWEEN THE MOD 1 TERMINALS W AND R.
- MINIMUM (DRIVE CLOSED) SIGNAL LESS THAN 0.17 VDC
- MAXIMUM (DRIVE OPEN) SIGNAL IS GREATER THAN 1.7 VDC
- 3 USE SEPARATE TRANSFORMER FOR T775M WHEN USING 24 VAC.
- 4 A 250 OHM RESISTOR PROVIDES 40% AUTHORITY WHEN USING A 150 OHM MINIMUM POSITION POTENTIOMETER.
- 5 INSERT 340 OHM RESISTOR (INCLUDED) ACROSS TERMINALS R AND W.
- 6 POWER WITH 24 VAC OR 120/240 VAC AT THE APPROPRIATE TERMINAL BLOCK.
- 7 24 VAC POWER TERMINAL BLOCK.

M28012

Fig. 43. T775M2030 wiring connections for replacing a W973A Logic Panel.

NOTE: The T775M2030 Replacement for W973A Logic Panel continues on the next page.

T775M2030 Replacement for W973A Logic Panel (continued)

In this replacement application, the T775M2030 provides the following, as described in Table 2.

Table 2. T775M2030 replacement for W973A

Component/Function	W973A Logic Panel	T775M2030 Replacement
Thermostat	T7067	Sensor A (Room) - C7130B1008.
Discharge Sensor	C7046	Sensor B (Discharge) - C7046D1008.
Heating/Cooling Motor	M954	Series 90, 4-20 mA, 0-10 Vdc, or 2-12 Vdc motor may be used.
Fan Start	Fan Start Relay	If a relay is available, it can be used for fan control (e.g., 1 stage Heat and 2 stage Cool using the T775M2030).
Economizer	M955	With the T775M2030 there are two modulating outputs. Therefore, two of the three functions (Heat, Cool, or Economizer) are available to be used. The example in Fig. 35 uses the Heat and Cool functions; no Economizer.
Outside Air Changeover	H205	Optional – SPDT Changeover (H705).

T775R Replacement for W964F Aquatrol Panel with Floating Actuator

This replacement example illustrates how a T77R is configured to replace a W964F Aquatrol Panel.

- Fig. 45 illustrates the wiring connections for the W964F Aquatrol Panel.
- Fig. 46 and Table 4 on page 34 illustrate the wiring and configuration of the T775R controller.

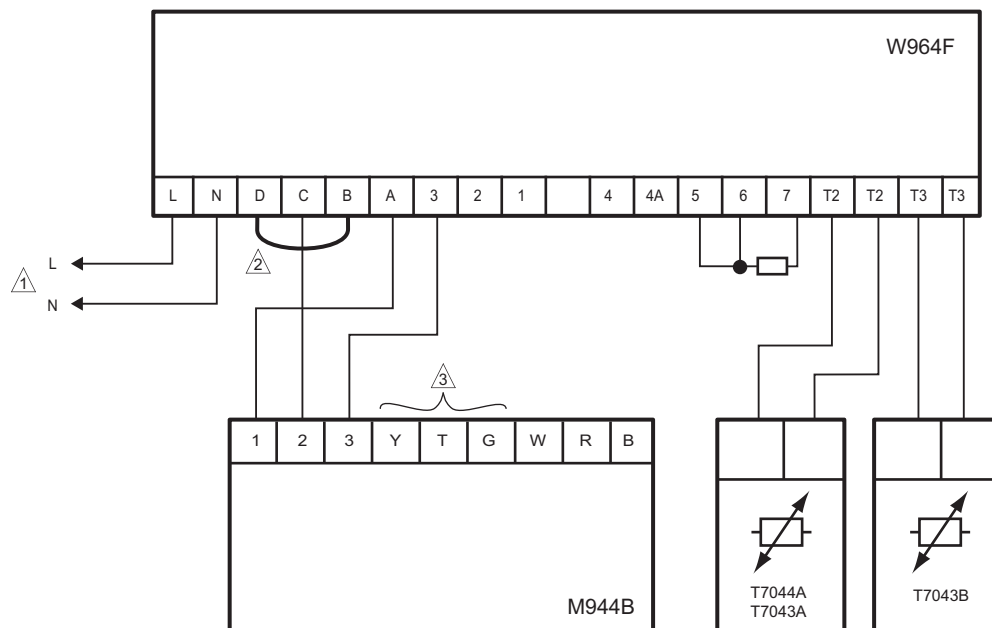

⚠ 120 V, 60 HZ POWER SUPPLY. PROVIDE DISCONNECT MEANS AND OVERLOAD PROTECTION AS REQUIRED.

⚠ JUMPER BETWEEN B AND D.

⚠ TERMINALS Y, T, AND G ARE NOT USED.

M28013

Fig. 44. W964F wiring connections (pre-existing Control).

NOTE: The T775R Replacement for W964F Aquatrol Panel with Floating Actuator continues on the next page.

T775R Replacement for W964F Aquatrol Panel with Floating Actuator (continued)

NOTE: Table 45 is for wiring purposes only. A thorough review of the existing W964F application is required in order to determine the capability of the T775 controller replacement.

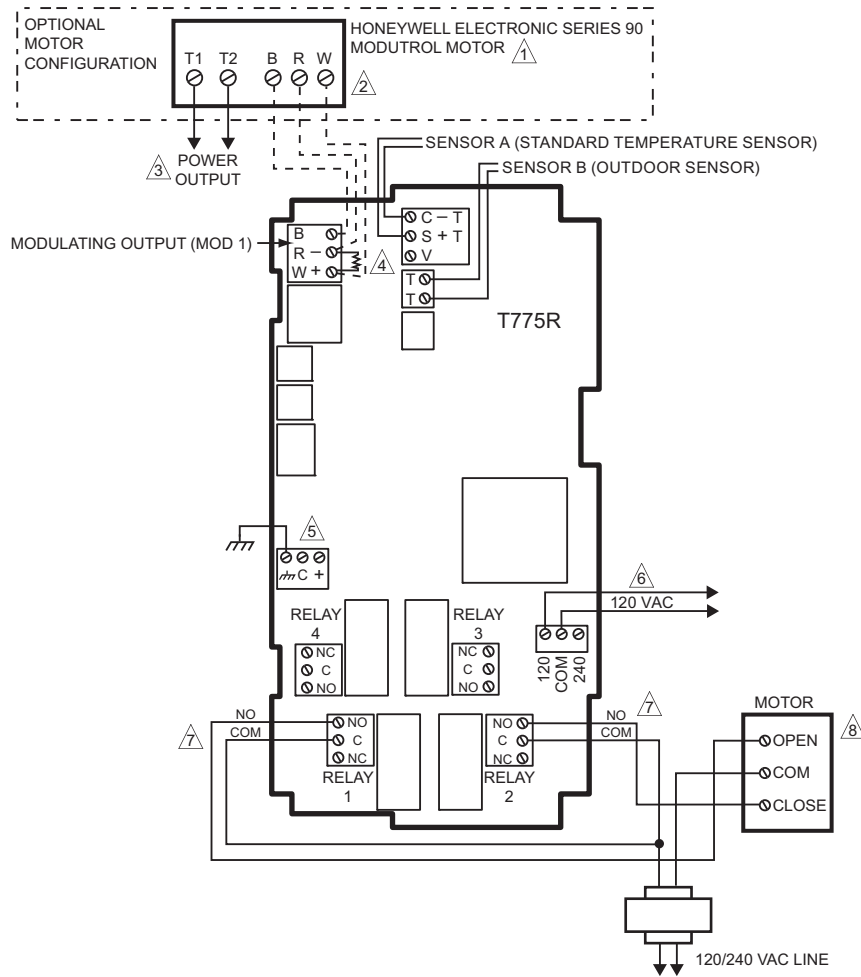

- 1 OTHER MOTORS SUCH AS 4-20 MA, 0-10 VDC, AND 2-10 VDC, MAY BE USED ON THE MOD 1 OUTPUT.
- 2 TO VERIFY OUTPUT, TEST OPEN CIRCUIT VOLTAGE BETWEEN THE MOD 1 TERMINALS W AND R.
 - MINIMUM (DRIVE CLOSED) SIGNAL LESS THAN 0.17 VDC
 - MAXIMUM (DRIVE OPEN) SIGNAL IS GREATER THAN 1.7 VDC
- 3 USE SEPARATE TRANSFORMER FOR T775R WHEN USING 24 VAC.
- 4 INSERT 340 OHM RESISTOR (INCLUDED) ACROSS TERMINALS R AND W.
- 5 24 VAC POWER TERMINAL BLOCK.
- 6 POWER WITH 24 VAC OR 120/240 VAC AT THE APPROPRIATE TERMINAL BLOCK.
- 7 RELAY 1 CLOSURES TO DRIVE DEVICE OPEN.
 RELAY 2 CLOSURES TO DRIVE DEVICE CLOSED.
- 8 MOTOR CAN BE AN M944B, M644, M6184, ML6984, ML6420, ETC.

M28014

Fig. 45. T775R wiring connections for replacing a W964F Aquatrol Panel.

NOTE: The T775R Replacement for W964F Aquatrol Panel with Floating Actuator continues on the next page.

T775R Replacement for W964F Aquatrol Panel with Floating Actuator (continued)

In this replacement application, the T775R provides the following, as described in Table 3.

Table 3. T775R replacement for W964F

Component/Function	W964F Aquatrol	T775R Replacement
Sensors	T7044A or T7043A T7043B	Sensor A - Standard 1097 Ohm temperature sensor. Sensor B - Standard 1097 Ohm temperature sensor. "See "Temperature Sensors1" on page 3..
Reset ratio and parallel shift	n/a	Reset programming in the T775R provides the reset curve.
On/Off motor control	Jumper terminals 1 and 2 on the W964F	If the W964F provided On/Off motor control, then wire motor to a relay output on the T775R to provide On/Off control.
Actuator motor speed	n/a	Use the Integral Time and Throttling Range to tune the T775R control.
Differential	n/a	Use the Throttling Range to tune the T775R control.
Program setback	n/a	The T775R provides Setback and alternate setpoint programming parameters.
Motor	M944B	Series 90, 4-20 mA, 0-10 Vdc, or 2-12 Vdc motor may be used.

T775L Replacement for S984 Step Controller

This replacement example illustrates how a T775L using a T775S Expansion module is configured to replace a S984 Step Controller.

NOTE: This replacement section also applies to the S684 Step Controller.

Fig. 46 illustrates the wiring connections for the S984 Step Controller.

Fig. 47 and Table 4 on page 40 illustrate the wiring and configuration of the T775L controller.

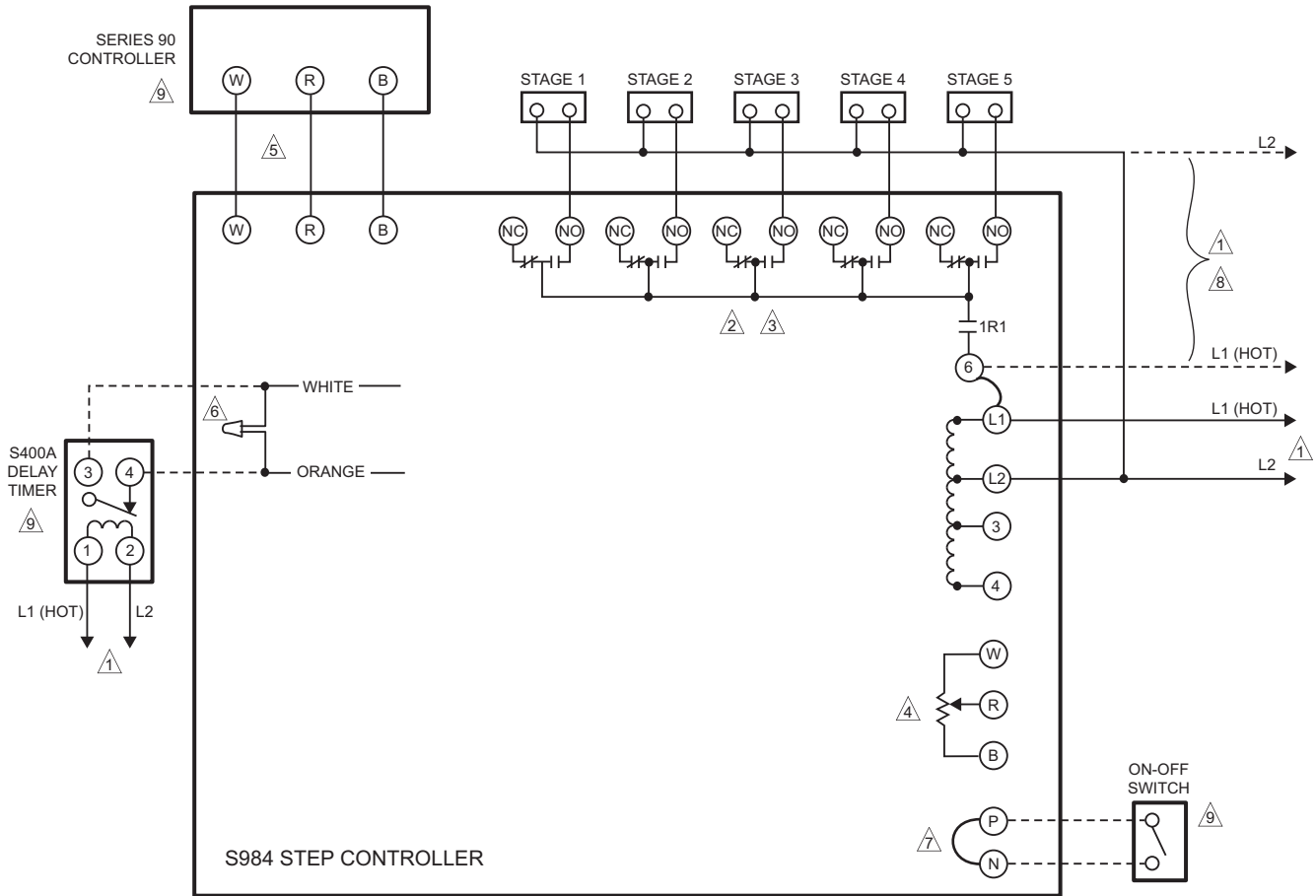

- ⚠️ 1 POWER SUPPLY. PROVIDE DISCONNECT MEANS AND OVERLOAD PROTECTION AS REQUIRED.
- ⚠️ 2 SWITCHES SHOWN WITH DEVICE ENERGIZED.
- ⚠️ 3 REFER TO SPECIFICATIONS FOR NUMBER OF SWITCHES.
- ⚠️ 4 AUXILIARY POTENTIOMETER ON S984J ONLY. TERMINAL LABELED "AUX."
- ⚠️ 5 THIS HOOKUP IS FOR A COOLING SYSTEM. FOR A HEATING SYSTEM, REVERSE W AND B.
- ⚠️ 6 WHEN SHIPPED, LEADS ARE JOINED WITH A WIRE NUT. TO DELAY STAGES ON, REMOVE WIRE NUT FROM ORANGE AND WHITE LEADS AND CONNECT TO DELAY TIMER. TO DELAY STAGES OFF, REMOVE WIRE NUT FROM BLUE AND WHITE LEADS AND CONNECT TO DELAY TIMER.
- ⚠️ 7 REMOVE JUMPER AND CONNECT ON-OFF SWITCH HERE IF S984 MUST RETURN TO START POSITION DURING OFF CYCLE.
- ⚠️ 8 CLIP OUT JUMPER (TERMINAL 6 TO L1) AND CONNECT SEPARATE POWER SOURCE HERE IF SEPARATION OF SWITCHING STAGES AND CONTROL OPERATION IS DESIRED.
- ⚠️ 9 NOT PART OF STEP CONTROLLER.

M28015

Fig. 46. S984 wiring connections (pre-existing control).

NOTE: The T775L replacement for S984 step controller continues on the next page.

T775L Replacement for S984 Step Controller (continued)

NOTE: Fig. 47 is for wiring purposes only. A thorough review of the existing S984 application is required in order to determine the capability of the T775 controller replacement.

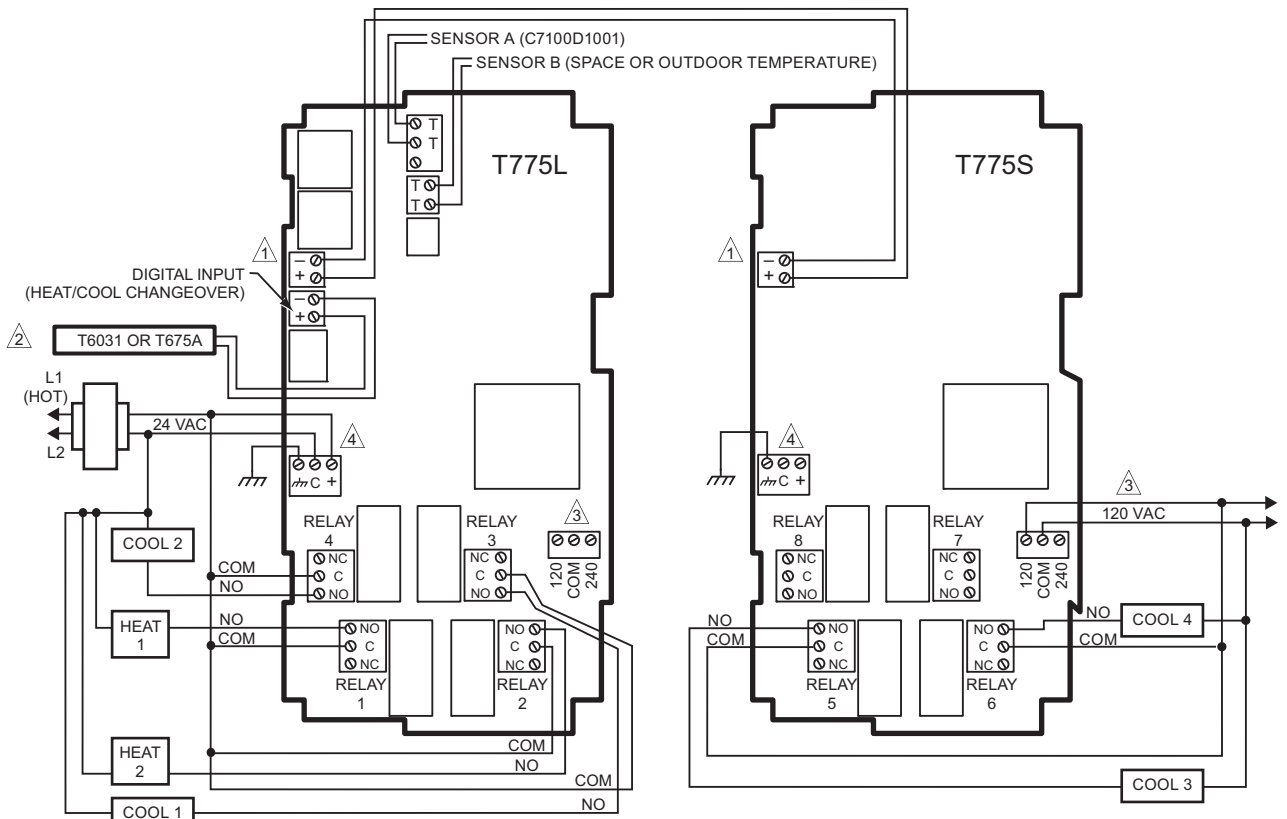

- ⚠ T775 BUS TERMINALS PROVIDE WIRING CONNECTIONS TO/FROM T775L AND T775S.
- ⚠ SETUP THE CONTROL (T6031 OR T675) SO THAT IT CLOSSES ON A TEMPERATURE FALL.
- ⚠ POWER WITH 24 VAC OR 120/240 VAC AT THE APPROPRIATE TERMINAL BLOCK.
- ⚠ 24 VAC POWER TERMINAL BLOCK.

M28018

Fig. 47. T775L wiring connections for replacing a S984 Step Controller.

In this replacement application, the T775L provides the following, as described in Table 4:

Table 4. T775L replacement for S684 or S984.

Component/Function	S684 or S984	T775L Replacement
Sensor	Series 60, Series 90, T915, T991, T921, W902, etc. controller	Sensor A - Standard 1097 Ohm temperature sensor. Sensor B - Standard 1097 Ohm temperature sensor; (required only if reset control is used; i.e. a T991B or W902A controller was used.) See "Temperature Sensors" on page 3. NOTE: If you are implementing two-sensor reset control, Sensor A must always be the controlled temperature and Sensor B must always be the controlling temperature. For example, in a reset control based on outside temperature, Sensor A must be the inside sensor and Sensor B must be the outside sensor.
Delay Timer	S400A	Use the On Delay and Off Delay programmable parameters of the T775L.
Throttling Range	n/a	Set the programmable Throttling Range parameter to match the application.
Reset	T991B or W902A (if used)	Reset programming in the T775L provides the reset curve.
Loads 1 - 5	n/a	Program the 5 relays into a single loop.
Auxiliary Pot.	S964J only	The T775L Controller with two T775S Expansion modules allows for up to 12 relay outputs.

T775L Replacement for W7100C Discharge Air Controller

This replacement example illustrates how a T775L using a T775S Expansion module is configured to replace a two-stage Heat and four-stage Cool W7100C Discharge Air Controller.

Fig. 48 illustrates the wiring connections for the W7100C Discharge Air Controller.

Fig. 49 and Table 5 on page 43 illustrate the wiring and configuration of the T775L controller.

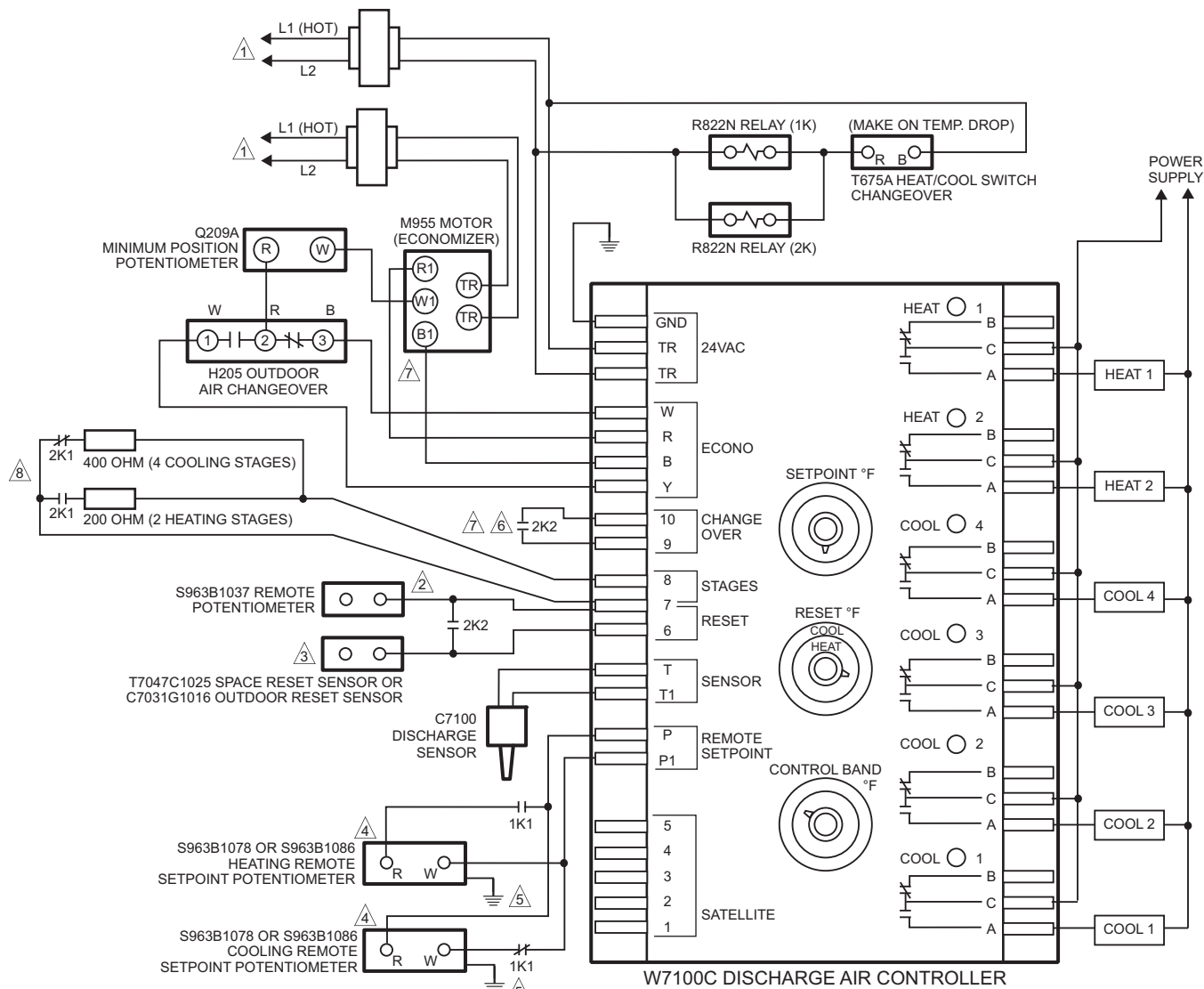

- 1 POWER SUPPLY. PROVIDE DISCONNECT MEANS AND OVERLOAD PROTECTION AS REQUIRED.
- 2 USE ONLY WITH SPACE RESET SENSOR. CONNECT IN SERIES AS SHOWN.
- 3 WHEN RESET NOT USED, JUMPER TERMINALS 6 AND 7.
- 4 SET HEAT AND COOL DISCHARGE SETPOINTS USING REMOTE SETPOINT POTENTIOMETERS. TURN SETPOINT KNOB ON W7100 TO MINIMUM POSITION. USE OF THE S963B1086 WILL CHANGE SETPOINT RANGE TO 40 TO 140°F.
- 5 GROUND CASE OF REMOTE SETPOINT POTENTIOMETER TO PREVENT PROBLEMS DUE TO STATIC ELECTRICITY.
- 6 WHEN CHANGEOVER TERMINALS 9 AND 10 ARE USED ON HEAT/COOL MODELS, JUMPER TERMINALS 9 AND 10 TO CHANGE OVER TO HEATING (LOCKS OUT COOLING WHEN JUMPED).
- 7 WHEN ECONOMIZER IS NOT USED, JUMPER TERMINALS Y AND 9 WITH THE 510 OHM, 1/4 WATT, 5 PERCENT RESISTOR CONTAINED IN THE 4074EFV BAG ASSEMBLY.
- 8 REMOVE FACTORY INSTALLED 400 OHM RESISTOR JUMPER AND RECONNECT FOR COOLING-ONLY MODE, 4-STAGE OPERATION (CHANGE VALUE FOR OTHER NUMBER OF STAGES). FOR 2-STAGES IN HEATING MODE, USE 200 OHM, 1/8 WATT RESISTOR FOR BEST OPERATION.

M28017

Fig. 48. W7100C wiring connections (pre-existing control).

NOTE: The T775L Replacement for W7100C Discharge Air Controller continues on the next page.

T775L Replacement for W7100C Discharge Air Controller (continued)

NOTE: Fig. 49 is for wiring purposes only. A thorough review of the existing W7100C application is required in order to determine the capability of the T775 controller replacement.

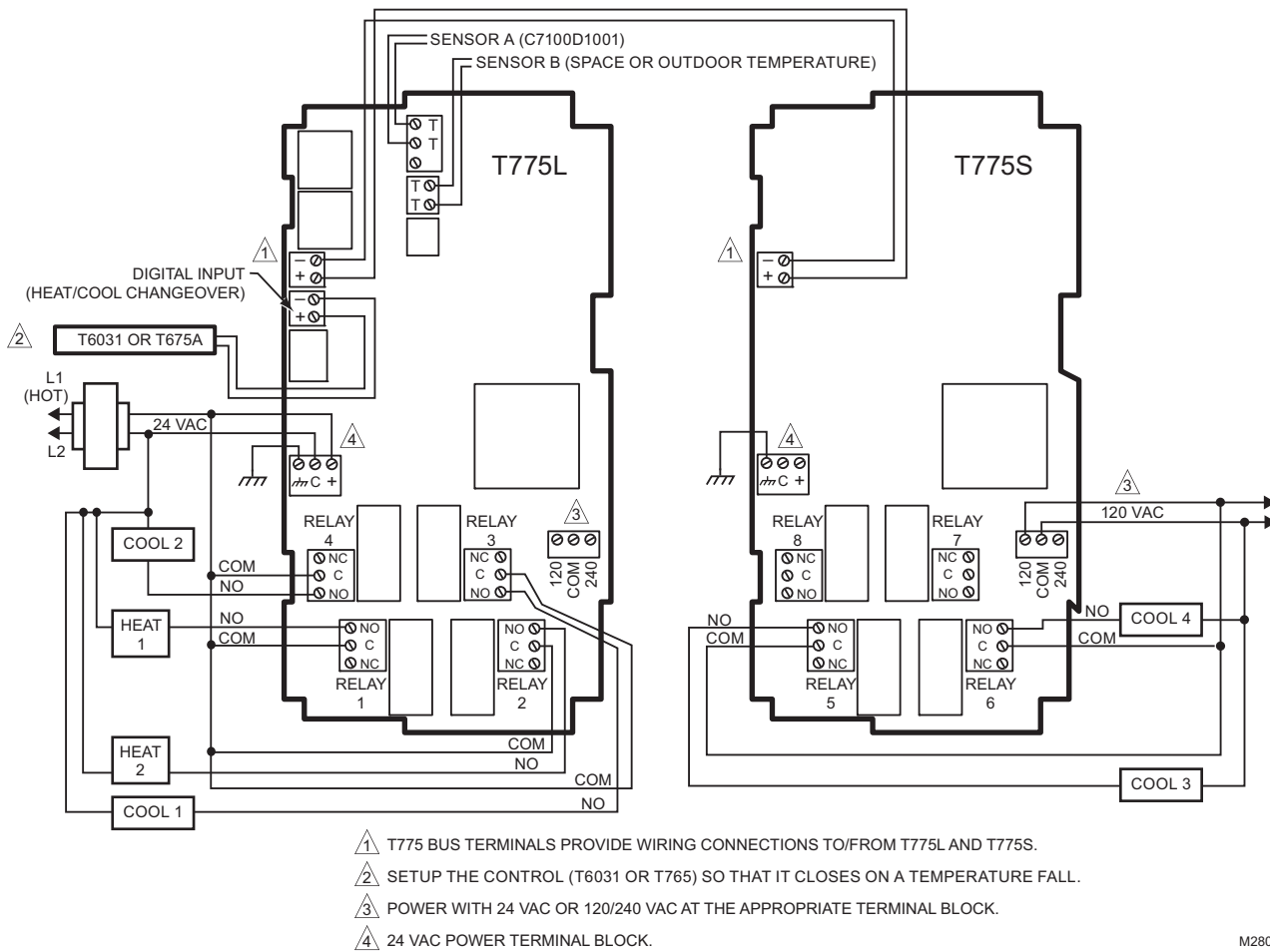

Fig. 49. T775L wiring connections for replacing a W7100C Discharge Air Controller.

NOTE: The T775L Replacement for W7100C Discharge Air Controller continues on the next page.

T775L Replacement for W7100C Discharge Air Controller (continued)

In this replacement application, the T775L provides the following, as described in Table 5:

Table 5. T775L Replacement for W7100C.

Component/Function	W7100C Discharge Air Controller	T775L Replacement
Sensor	C7100	Sensor A - C7100D1001
	T7047C1025 and S963B1037	Sensor B - Standard 1097 Ohm temperature sensor; space or outdoor See "Temperature Sensors" on page 3.
Economizer	M955, Q209A, and H705	The T775L can not provide a direct economizer function. However, an output relay can be used to enable a separate economizer module (e.g., W7212) to provide economization.
Heat/Cool switch changeover	T675A	Connect the Digital Input terminal to an outdoor temperature control, e.g. T6031 or T675A). Program the Digital Input for Setback using -40° F (-40° C) for the T675A cooling setpoint to lock out the cooling system during cold weather.
Setpoint and Reset	• Setpoint and Reset dial	Reset programming in the T775L provides the reset curve.
	• S963B1078 or S963B1086	Remote setpoint adjustment is not possible.
	• S963B1037 and T7047C1025	NOTES: 1. Reset can be used for Heating or Cooling, but not both. 2. Remote adjustment of the reset curve is not possible.
Control Band	Control Band dial	Set the programmable Throttling Range parameter to match the application.
Satellite (if used)	W7101A (if used)	By adding up to two T775S Expansion modules, you have up to 12 relays available.

T775 CROSS REFERENCE

Table 6 lists the manufacturers in the following order:

- Johnson (System 350) — beginning on page 44.
- Honeywell — beginning on page 45.

- Johnson (Mechanical) — beginning on page 49.
- White Rogers — beginning on page 51.
- Barber Colman — beginning on page 52.
- Ranco — beginning on page 53.
- Tekmar — beginning on page 54

Table 6. Cross Reference.

Old Control	Manufacturer	Temperature ° F/ Humidity Range (RH)	Switch Action	Cap Length	Recommended Honeywell Electromechanical Replacement	Honeywell Well # (Order Sep.)	Recommended Honeywell Electronic Replacement	Honeywell Well # (Order Sep.)	Comments
NOTE: For all T775 Series 2000 Controllers, the Setpoint Temperature Range is -40° to 248° F (-40° to 120° C).									
Johnson System 350									
A350A/B	Johnson						T775A2009		Johnson model: 1 SPDT temperature
A350A/B with 1 S350	Johnson						T775B2032		Johnson model: Multiple SPDT temperature
A350A/B with up to 3 S350s	Johnson						T775B2040		Johnson model: Multiple SPDT temperature
A350A/B with more than 3 S350s	Johnson						T775B2040 plus additional T775Bs as needed.		Johnson model: Multiple SPDT temperature
A350P	Johnson						T775M2006		Johnson model: 1 mod temperature
A350P with up to 2 S350s	Johnson						T775M2048		Johnson model: 1 mod temperature with relays
A350P with up to 4 S350s	Johnson						T775M2030		Johnson model: 1 mod temperature with relays
A350R with up to 3 S350s	Johnson						T775R2001 or T775R2035		Johnson model: Mod temperature with reset and SPDTs
A350S with up to 4 S350s	Johnson						T775R2001 or T775R2035		Johnson model: Mod temperature with reset and SPDTs
A350P with A350R	Johnson						T775R2043		Johnson model: 1 mod temperature with reset
A350P with A350R and multiple S350s	Johnson						T775R2027 or T775R2019		Johnson model: 1 mod temperature with reset and SPDTs
R353 with S353s	Johnson						T775L2007 or T775P2003		Johnson model: Sequenced relays
W351A	Johnson						T775U2006		Johnson model: 1 SPDT humidity

Table 6. Cross Reference. (Continued)

Old Control	Manufacturer	Temperature ° F/ Humidity Range (RH)	Switch Action	Cap Length	Recommended Honeywell Electromechanical Replacement	Honeywell Well # (Order Sep.)	Recommended Honeywell Electronic Replacement	Honeywell Well # (Order Sep.)	Comments
W351A with 1 S351	Johnson						T775U2006		Johnson model: 2 SPDT humidity
W351P	Johnson						T775U2006		Johnson model: 1 mod humidity
P352	Johnson						T775U2006		Johnson model: 1 mod pressure
P352 with up to 2 S352s	Johnson						T775U2006		Johnson model: 1 mod pressure with 2 SPDT
Any system with D350	Johnson						See comment.		All T775 Series 2000 controllers have an LCD display
Any system with Y350	Johnson						See comment.		All T775 Series 2000 controllers can accept 24 Vac, 120/240 Vac
A319	Johnson						T775A2009		Johnson model: 1 SPDT with no display
A419	Johnson						T775A2009		Johnson model: 1 SPDT with small display
Honeywell									
H775A1006	Honeywell	5 to 95% RH	1-SPDT				T775U2006	5001774-001	
H775A1022	Honeywell	5 to 95% RH	2-SPDT				T775U2006	5001774-001	
H775A1048	Honeywell	5 to 95% RH	3-SPDT				T775U2006	5001774-001	T775U has only 2 relays
H775A1063	Honeywell	5 to 95% RH	4-SPDT				T775U2006	5001774-001	T775U has only 2 relays
H775B1005	Honeywell	5 to 95% RH	2-SPDT				T775U2006	5001774-001	
H775C1004	Honeywell	5 to 95% RH	4-SPDT				T775U2006	5001774-001	T775U has only 2 relays
H775D1003	Honeywell	5 to 95% RH	2-SPDT				T775U2006	5001774-001	
H775E1002	Honeywell	5 to 95% RH	2-SPDT				T775U2006	5001774-001	
T4031A1008	Honeywell	-30 to 50	SPST	5 ft.			T775A2009	5001774-001	
T4031A1016	Honeywell	-30 to 50	SPST	5 ft.			T775A2009	5001774-001	
T4031A1073	Honeywell	-30 to 90	SPST	8 ft.			T775A2009	5001774-001	
T4031C1004	Honeywell	40 to 180	SPST	7.5 ft.			T775A2009	5001774-001	
T4031C1012	Honeywell	40 to 180	SPST	5.5 ft.			T775A2009	5001774-001	
T4031E1009	Honeywell	40 to 180	SPST	5.5 ft.			T775A2009	5001774-001	
T4031F1007	Honeywell	40 to 180	SPST	5.5 ft.			T775A2009	5001774-001	
T4031H1003	Honeywell	35 to 45	SPST	5.5 ft.			T775A2009	5001774-001	
T4031J1016	Honeywell	35 to 45	SPST	5.5 ft.			T775A2009	5001774-001	
T475A1016	Honeywell	70 to 140	SPST	10/30 ft.			T775R2035	5001774-001	The T775R is a Reset controller
T475A1032	Honeywell	70 to 140	SPST	10/30 ft.			T775R2035	5001774-001	The T775R is a Reset controller
T475A1057	Honeywell	70 to 140	SPST	10/30 ft.			T775R2035	5001774-001	The T775R is a Reset controller

Table 6. Cross Reference. (Continued)

Old Control	Manufacturer	Temperature ° F/ Humidity Range (RH)	Switch Action	Cap Length	Recommended Honeywell Electromechanical Replacement	Honeywell Well # (Order Sep.)	Recommended Honeywell Electronic Replacement	Honeywell Well # (Order Sep.)	Comments
T6031A1011	Honeywell	15 to 90	SPDT	5 ft.			T775A2009	5001774-001	
T6031A1029	Honeywell	-30 to 90	SPDT	8 ft.			T775A2009	5001774-001	
T6031A1045	Honeywell	-30 to 50	SPDT	5 ft.			T775A2009	5001774-001	
T6031A1052	Honeywell	-30 to 50	SPDT	5 ft.			T775A2009	5001774-001	
T6031A1060	Honeywell	-30 to 90	SPDT	20 ft.			T775A2009	5001774-001	
T6031A1086	Honeywell	-31 to 86	SPDT	8 ft.			T775A2009	5001774-001	
T6031A1136	Honeywell	-30 to 90	SPDT	8 ft.			T775A2009	5001774-001	
T6031A1250	Honeywell	-20 to 100	SPDT	5 ft.			T775A2009	5001774-001	
T6031C1009	Honeywell	40 to 180	SPDT	5.5 ft.			T775A2009	5001774-001	
T6031C1025	Honeywell	0 to 90	SPDT	5.5 ft.			T775A2009	5001774-001	
T6031C1033	Honeywell	40 to 80	SPDT	5.5 ft.			T775A2009	5001774-001	
T6031C1041	Honeywell	41 to 176	SPDT	5.5 ft.			T775A2009	5001774-001	
T6031C1058	Honeywell	100 to 240	SPDT	5 ft. stainless			T775A2009	5001774-001	Use stainless well
T6031D1007	Honeywell	40 to 180	SPDT	7.5 ft. armored			T775A2009	5001774-001	Protect sensor wires
T6031D1015	Honeywell	40 to 180	SPDT	5.5 ft.			T775A2009	5001774-001	
T6031D1031	Honeywell	0 to 70	SPDT	5.5 ft.			T775A2009	5001774-001	
T6031D1049	Honeywell	30 to 270	SPDT	5.5 ft.			T775A2009	5001774-001	
T6031E1004	Honeywell	40 to 180	SPDT	5.5 ft.			T775A2009	5001774-001	
T6031F1010	Honeywell	55 to 90	SPDT	5.5 ft.			T775A2009	5001774-001	
T6031G1000	Honeywell	0 to 90	SPDT	6 ft.			T775A2009	5001774-001	
T6031J1003	Honeywell	55 to 85	SPDT	5.5 ft.			T775A2009	5001774-001	
T6031K1001	Honeywell	15 to 75	SPDT	5.5 ft.			T775A2009	5001774-001	
T675A1045	Honeywell	0 to 100	SPDT	20 ft. stainless			T775A2009	5001774-001	Use stainless well
T675A1102	Honeywell	160 to 260	SPDT	20 ft.			T775A2009	5001774-001	
T675A1136	Honeywell	0 to 100	SPDT	20 ft.			T775A2009	5001774-001	
T675A1243	Honeywell	167 to 257	SPDT	5 ft.			T775A2009	5001774-001	
T675A1425	Honeywell	55 to 175	SPDT	20 ft.			T775A2009	5001774-001	
T675A1441	Honeywell	55 to 175	SPDT	20 ft. stainless			T775A2009	5001774-001	Use stainless well
T675A1458	Honeywell	55 to 175	SPDT	5 ft.			T775A2009	5001774-001	
T675A1508	Honeywell	0 to 100	SPDT	5 ft.			T775A2009	5001774-001	

Table 6. Cross Reference. (Continued)

Old Control	Manufacturer	Temperature ° F/ Humidity Range (RH)	Switch Action	Cap Length	Recommended Honeywell Electromechanical Replacement	Honeywell Well # (Order Sep.)	Recommended Honeywell Electronic Replacement	Honeywell Well # (Order Sep.)	Comments
T675A1516	Honeywell	0 to 100	SPDT	5 ft.			T775A2009	5001774-001	
T675A1524	Honeywell	55 to 175	SPDT	20 ft.			T775A2009	5001774-001	
T675A1532	Honeywell	160 to 260	SPDT	5 ft.			T775A2009	5001774-001	
T675A1540	Honeywell	55 to 175	SPDT	5 ft.			T775A2009	5001774-001	
T675A1565	Honeywell	0 to 100	SPDT	20 ft.			T775A2009	5001774-001	
T675A1706	Honeywell	0 to 100	SPDT	5 ft.			T775A2009 + C7100D1001		Fast response; Clip Capacitor
T675A1722	Honeywell	55 to 175	SPDT	5 ft.			T775A2009 + C7100D1001		Fast response; Clip Capacitor
T675A1771	Honeywell	55 to 175	SPDT	5 ft.			T775A2009 + C7100D1001		Fast response; Clip Capacitor
T675A1854	Honeywell	10 to 110	SPDT	5 ft.			T775A2009 + C7100D1001		Fast response; Clip Capacitor
T675B1002	Honeywell	30 to 50	SPDT	10 ft.			T775A2009	5001774-001	Add S445A1010 to convert T775 to manual reset
T675B1010	Honeywell	30 to 50	SPDT	20 ft.			T775A2009	5001774-001	Add S445A1010 to convert T775 to manual reset
T675B1028	Honeywell	-20 to 50	SPDT	10 ft.			T775A2009	5001774-001	Add S445A1010 to convert T775 to manual reset
T675B1032	Honeywell	80 to 220	SPDT	10 ft.			T775A2009 + 50021579-001 (x3) or + C7031J2009 or + C7100D1001		Averaging
T678A1015	Honeywell	0 to 100	2-SPDT	20 ft.			T775B2032	5001774-001	
T678A1080	Honeywell	160 to 260	2-SPDT	5 ft.			T775B2032	5001774-001	
T678A1163	Honeywell	5 to 95	2-SPDT	20 ft.			T775B2032	5001774-001	
T678A1361	Honeywell	55 to 175	2-SPDT	20 ft.			T775B2032	5001774-001	
T678A1437	Honeywell	0 to 100	2-SPDT	5 ft.			T775B2032	5001774-001	
T678A1445	Honeywell	55 to 175	2-SPDT	5 ft.			T775B2032	5001774-001	
T775A1001	Honeywell	-20 to 240	1-SPDT				T775A2009		
T775A1019	Honeywell	-20 to 240	2-SPDT				T775B2032		
T775A1027	Honeywell	-20 to 240	3-SPDT				T775B2040		
T775A1035	Honeywell	-20 to 240	4-SPDT				T775B2040		
T775A1068	Honeywell	55 to 175	2-SPDT				T775B2040	5001774-001	
T775B1000	Honeywell	-20 to 240	2-SPDT				T775B2032		

Table 6. Cross Reference. (Continued)

Old Control	Manufacturer	Temperature ° F/ Humidity Range (RH)	Switch Action	Cap Length	Recommended Honeywell Electromechanical Replacement	Honeywell Well # (Order Sep.)	Recommended Honeywell Electronic Replacement	Honeywell Well # (Order Sep.)	Comments
T775B1018	Honeywell	-20 to 240	3-SPDT				T775B2040		
T775B1026	Honeywell	-20 to 240	4-SPDT				T775B2040		
T775B1042	Honeywell	-20 to 220	4-SPDT				T775B2040		
T775C1009	Honeywell	-20 to 240	4-SPDT				T775B2024		
T775D1008	Honeywell	-20 to 240	4-SPDT				T775B2024		
T775E1015	Honeywell	-20 to 220	1-SPDT				T775M2048		
T775E1023	Honeywell	-20 to 220	2-SPDT				T775M2048		
T775E1056	Honeywell	-20 to 220	1-SPDT				T775M2048		
T775E1064	Honeywell	-20 to 220	2-SPDT				T775M2048		
T775E1098	Honeywell	-20 to 220	1-SPDT				T775M2048		
T775E1114	Honeywell	-20 to 220	3-SPDT				T775M2030		
T775F1022	Honeywell	-20 to 220	3-SPDT				T775M2030		
T775F1055	Honeywell	-20 to 220	3-SPDT				T775M2030		
T775F1089	Honeywell	-20 to 220	3-SPDT				T775M2030		
T775G1005	Honeywell	-20 to 220	3-SPDT				T775M2014		
T775G1013	Honeywell	-20 to 220	3-SPDT				T775M2014		
T775G1021	Honeywell	-20 to 220	3-SPDT				T775M2014		
T775G1039	Honeywell	-20 to 220	4-SPDT				T775M2014		
T775J1001	Honeywell	-20 to 240	1-SPDT				T775R2035		
T775J1019	Honeywell	-20 to 240	None				T775R2043		
T775J1027	Honeywell	-20 to 240	None				T775R2043		
T775J1035	Honeywell	-20 to 240	None				T775R2043		
T775J1043	Honeywell	-20 to 240	1-SPDT				T775R2027		
T775J1050	Honeywell	-20 to 240	1-SPDT				T775R2027		
T775J1068	Honeywell	-20 to 240	1-SPDT				T775R2027		
T775J1076	Honeywell	-20 to 240	2-SPDT				T775R2035		

Table 6. Cross Reference. (Continued)

Old Control	Manufacturer	Temperature ° F/ Humidity Range (RH)	Switch Action	Cap Length	Recommended Honeywell Electromechanical Replacement	Honeywell Well # (Order Sep.)	Recommended Honeywell Electronic Replacement	Honeywell Well # (Order Sep.)	Comments
Johnson (Mechanical)									
A19ABA-40	Johnson	-30 to 100	SPST	No cap	T4031A1073	1/2" - 123869A 3/4" - 123870A	T775A2009	5001774-001	
A19ABC-4	Johnson	50 to 130	SPDT	8 ft.	T675A1425	1/2" - 112622AA 3/4" - 112630AA	T775A2009	5001774-001	
A18ABC-24	Johnson	-30 to 100	SPDT	8 ft.	T6031A1136	1/2" - 123869A 3/4" - 123870A	T775A2009	5001774-001	
A19ABC-36	Johnson	-30 to 100	SPDT	20 ft.	T6031A1060	1/2" - 123869A 3/4" - 123870A	T775A2009	5001774-001	
A19ABC-37	Johnson	-30 to 100	SPDT	10 ft.	T6031A1060	1/2" - 123869A 3/4" - 123870A	T775A2009	5001774-001	
A19ACC-4	Johnson	0 to 80	SPDT	6 ft.	T6031A1136	1/2" - 123869A 3/4" - 123870A	T775A2009	5001774-001	
A19AAD-5	Johnson	30 to 50	SPST	6 ft.	None	None	T775A2009	5001774-001	
A19AAD-12	Johnson	-30 to 50	SPST	7 ft.	T6031A1136	1/2" - 123869A 3/4" - 123870A	T775A2009	5001774-001	
A19AAF-12	Johnson	25 to 225	SPDT	10 ft.	None	1/2" - 123869A 3/4" - 123870A	T775A2009	5001774-001	
A19AAF-20	Johnson	-30 to 100	SPDT	6 ft.	T6031A1136	1/2" - 123869A 3/4" - 123870A	T775A2009	5001774-001	
A19AAF-21	Johnson	40 to 90	SPDT	6 ft.	T6031A1136	1/2" - 123869A 3/4" - 123870A	T775A2009	5001774-001	
A19ACA-14	Johnson	-30 to 100	SPST	6 ft.	L480G1044 (20 to 60° F)	None	T775A2009	5001774-001	Add S445A1010 to convert T775 to manual reset
A19ACA-15	Johnson	-30 to 100	SPST	10 ft.	L480G1044	None	T775A2009	5001774-001	Add S445A1010 to convert T775 to manual reset
A19ADB-1	Johnson	100 to 240	SPST	6 ft.	L4008E1156 (110 to 290° F)	121371L (3 in. insulation)	T775A2009	5001774-001	Add S445A1010 to convert T775 to manual reset
A19AAB-4	Johnson	30 to 110	SPST	6 ft.	T675A1425 (55 to 175° F)	1/2" - 112622AA 3/4" - 112630AA	T775A2009	5001774-001	
A19AAC-9	Johnson	100 to 240	SPDT	6 ft.	L6008A1192	121371L (3 in. insulation)	T775A2009	5001774-001	
A28AA-8	Johnson	-30 to 50	2-SPDT	6 ft.	T678A1437 (0 to 110° F)	1/2" - 112622AA 3/4" - 112630AA	T775B2032	5001774-001	T678 has no weatherproof enclosure

Table 6. Cross Reference. (Continued)

Old Control	Manufacturer	Temperature ° F/ Humidity Range (RH)	Switch Action	Cap Length	Recommended Honeywell Electromechanical Replacement	Honeywell Well # (Order Sep.)	Recommended Honeywell Electronic Replacement	Honeywell Well # (Order Sep.)	Comments
A28AA-9	Johnson	20 to 80	2-SPDT	6 ft.	T678A1437	1/2" - 112622AA 3/4" - 112630AA	T775B2032	5001774-001	T678 has no weatherproof enclosure
A28AA-28	Johnson	30 to 110	2-SPDT	6 ft.	T678A1478 (fast response)	None	T775B2032 + 50021579-001 (x3) or + C7031J2009 or + C7100D1001	5001774-001	T678 has no weatherproof enclosure
A28AA-29	Johnson	-30 to 110	2-SPDT	8 ft.	T678A1627 (0 to 100° F)	1/2" - 112622AA 3/4" - 112630AA	T775B2032	5001774-001	T678 has no weatherproof enclosure
A28AA-36	Johnson	40 to 90	2-SPDT	6 ft.	T678A1437 (0 to 100° F)	1/2" - 112622AA 3/4" - 112630AA	T775B2032	5001774-001	T678 has no weatherproof enclosure
A28AA-37	Johnson	60 to 140	2-SPDT	6 ft.	T678A1445 (55 to 175° F)	1/2" - 112622AA 3/4" - 112630AA	T775B2032	5001774-001	T678 has no weatherproof enclosure
A28AJ-4	Johnson	20 to 80	2-SPDT	6 ft.	T678A1437 (0 to 100° F)	1/2" - 112622AA 3/4" - 112630AA	T775B2032	5001774-001	T678 has no weatherproof enclosure
A28KA-1	Johnson	0 to 150	2-SPDT	10 ft.	T678A143 (0 to 100° F) or T678A1445 (55 to 175° F)	1/2" - 112622AA 3/4" - 112630AA	T775B2024	5001774-001	T678 has no weatherproof enclosure
A28MA-1	Johnson	40 to 120	2-SPDT	6 ft.	T678A1437 (0 to 100° F) or T678A1445 (55 to 175° F)	1/2" - 112622AA 3/4" - 112630AA	T775B2024	5001774-001	T678 has no weatherproof enclosure
A28MA-2	Johnson	40 to 120	2-SPDT	6 ft.	T678A1437 (0 to 100° F) or T678A1445 (55 to 175° F)	1/2" - 112622AA 3/4" - 112630AA	T775B2024	5001774-001	T678 has no weatherproof enclosure
A36AHA-50	Johnson	55 to 95	4-SPDT	18 in.	None	112620BB	T775B2040	5001774-001	
A36AHA-52	Johnson	55 to 95	4-SPDT	6 ft.	None	112620BB	T775B2040	5001774-001	
A36AHA-58	Johnson	0 to 70	4-SPDT	15 ft.	None	112620BB	T775B2040	5001774-001	
A36AHB-33	Johnson	0 to 70	4-SPDT	15 ft.	None	112620BB	T775B2040	5001774-001	
A80ABA-1	Johnson	-20 to 50	135 Ohm	6 ft.	T991A2044	121371Q	T775M2048	5001774-001	T991 has 5 ft. cap; other models available
A80ABA-2	Johnson	10 to 90	135 Ohm	6 ft.	T991A1426	112622AA	T775M2048	5001774-001	T991 has 5 ft. cap; other models available

Table 6. Cross Reference. (Continued)

Old Control	Manufacturer	Temperature ° F/ Humidity Range (RH)	Switch Action	Cap Length	Recommended Honeywell Electromechanical Replacement	Honeywell Well # (Order Sep.)	Recommended Honeywell Electronic Replacement	Honeywell Well # (Order Sep.)	Comments
A80ABA-3	Johnson	60 to 140	135 Ohm	6 ft.	T991A1244	121371Q	T775M2048	5001774-001	T991 has 5 ft. cap; other models available
A80ABA-4	Johnson	120 to 200	135 Ohm	6 ft.	T915C1928	112622AA	T775M2048	5001774-001	T915 has 5 ft. cap; other models available
A80ABA-5	Johnson	190 to 260	135 Ohm	6 ft.	T991A1061	112622AA	T775M2048	5001774-001	
A80ABA-22	Johnson	85 to 245	135 Ohm	6 ft.	T915D1273	112622AA	T775M2048	5001774-001	
A80ACA-1	Johnson	60 to 140	135 Ohm	6 ft.	None	—	T775M2048		
A80ACA-7	Johnson	10 to 90	135 Ohm	6 ft.	None	None	T775M2048		
A80ADA-1	Johnson	10 to 90	135 Ohm	6 ft.	None	None	T775M2048		
A80ADA-2	Johnson	60 to 140	135 Ohm	6 ft.	None		T775M2048		
White Rodgers									
1609-90	White Rodgers	-20 to 50	SPST	8 ft.	T4031A1073	1/2" - 123869A	T775A2009	5001774-001	
						3/4" - 123870A			
1609-101	White Rodgers	-30 to 90	SPST	5 ft.	T4031A1073	1/2" - 123869A	T775A2009	5001774-001	
						3/4" - 123870A			
1609-102	White Rodgers	-30 to 90	SPST	8 ft.	T4031A1073	1/2" - 123869A	T775A2009	5001774-001	
						3/4" - 123870A			
1609-103	White Rodgers	-30 to 90	SPST	10 ft.	T4031A1073 (8 ft. cap)	1/2" - 123869A	T775A2009	5001774-001	
						3/4" - 123870A			
1609-104	White Rodgers	-30 to 90	SPST	20 ft.	T6031A1060	1/2" - 123869A	T775A2009	5001774-001	
						3/4" - 123870A			
1609-105	White Rodgers	-30 to 90	SPST	5 ft.	T4031A1073	1/2" - 123869A	T775A2009	5001774-001	
						3/4" - 123870A			
1609-106	White Rodgers	-30 to 90	SPST	5 ft.	T675A1706 (0 to 100° F° F)	None	T775A2009	5001774-001	Fast response element
1609-114	White Rodgers	20 to 90	SPST	8 ft.	T4031A1073	1/2" - 123869A	T775A2009	5001774-001	
						3/4" - 123870A			
1687-9	White Rodgers	-30 to 90	SPST	8 ft.	T6031A1136	1/2" - 123869A	T775A2009	5001774-001	
						3/4" - 123870A			
2A38-14	White Rodgers	20 to 120	SPDT	20 ft.	T675A1565 (0 to 100° F)	1/2" - 112622AA	T775A2009	5001774-001	
						3/4" - 112630AA			
230-22	White Rodgers	20 to 120	SPST	8 ft.	T4031A1004 (40 to 180° F)	1/2" - 123869A	T775A2009	5001774-001	
						3/4" - 123870A			

Table 6. Cross Reference. (Continued)

Old Control	Manufacturer	Temperature ° F/ Humidity Range (RH)	Switch Action	Cap Length	Recommended Honeywell Electromechanical Replacement	Honeywell Well # (Order Sep.)	Recommended Honeywell Electronic Replacement	Honeywell Well # (Order Sep.)	Comments
230-22	White Rodgers	20 to 120	SPST	8 ft.	T4031A1004 (40 to 180° F)	1/2" - 123869A 3/4" - 123870A	T775A2009	5001774-001	
241-2	White Rodgers	20 to 90	SPST	8 ft.	T4031A1073	1/2" - 123869A 3/4" - 123870A	T775A2009	5001774-001	
241-16	White Rodgers	20 to 90	SPST	8 ft.	T4031A1073	1/2" - 123869A 3/4" - 123870A	T775A2009	5001774-001	
445-6	White Rodgers	20 to 90	SPDT	5 ft.	T6031A1136	1/2" - 123869A 3/4" - 123870A	T775A2009	5001774-001	
16A35-3	White Rodgers	N/A	SPST	7 ft.	None	None	None	None	Ice-Trol
1050-1	White Rodgers				Select T475 with correct ratio	1/2" - 121371 P 3/4" - 121371 Q	T775R2035		The T775R is a Reset controller
Barber Colman									
TC282	Barber Colman	10 to 90	3-SPDT	6 ft.	None	112620BB	T775B2040		
TC282-20	Barber Colman	10 to 90	3-SPDT	20 ft.	None	112620BB	T775B2040		
TC288	Barber Colman	10 to 90	4-SPDT	6 ft.	None	112620BB	T775B2040		
TC-4111	Barber Colman	-40 to 120	SPDT	6 ft.	T6031A1136 (-30 to 90° F)	1/2" - 123869A 3/4" - 123870A	T775A2009		
TC-4111-020	Barber Colman	-40 to 120	SPDT	20 ft.	T6031A1136 (-30 to 90° F)	1/2" - 123869A 3/4" - 123870A	T775A2009	5001774-001	
TC4112	Barber Colman	100 to 260	SPDT	6 ft.	L6008A1192 (100 to 240° F)	121371A	T775A2009		
TC4115	Barber Colman	-40 to 120	SPDT	6'	T6031A1136 (-30 to 90° F)	1/2" - 123869A 3/4" - 123870A	T775A2009		
TC4151	Barber Colman	70 to 120	SPDT	30 ft.	T475A1057	1/2" - 121371P 3/4" - 121371Q	T775R2035	5001774-001	The T775R is a Reset controller
TC4152	Barber Colman	70 to 120	SPDT	30 ft.	T475A1032	1/2" - 121371P 3/4" - 121371Q	T775R2035		The T775R is a Reset controller
TC4211	Barber Colman	-40 to 120	SPDT	6 ft.	T678A1437 (0 to 100° F)	1/2" - 11262AA 3/4" - 112630AA	T775B2032		
TC4251	Barber Colman	70 to 120	SPDT	30 ft.	None	1/2" - 112622AA 3/4" - 112630AA	T775R2035	5001774-001	The T775R is a Reset controller

Table 6. Cross Reference. (Continued)

Old Control	Manufacturer	Temperature ° F/ Humidity Range (RH)	Switch Action	Cap Length	Recommended Honeywell Electromechanical Replacement	Honeywell Well # (Order Sep.)	Recommended Honeywell Electronic Replacement	Honeywell Well # (Order Sep.)	Comments
TC4252	Barber Colman	70 to 120	SPDT	30 ft.	T678B1006	1/2" - 112622AA 3/4" - 112630AA	T775R2035	5001774-001	The T775R is a Reset controller
TC4316	Barber Colman	-40 to 120	SPDT	6 ft.	None	—	T775B2032	5001774-001	
TC4416	Barber Colman	-40 to 120	2-SPDT	6 ft.	None	None	T775B2040	5001774-001	
TC5131	Barber Colman	34 to 60	SPDT	20 ft.	L480B1239	None	T775A2009	5001774-001	
TC5141	Barber Colman	34 to 60	SPDT	20 ft.	L480G1044	None	T775A2009	5001774-001	Add S445A1010 to convert T775 to manual reset
Ranco									
ETC-111000	Ranco						T775A2009		
ETC-111100	Ranco						T775M2048		
ETC-112000	Ranco						T775M2048		
ETC-112100	Ranco						T775M2048		
ETC-141000	Ranco						T775B2016		
ETC-211000	Ranco						T775B2932		
ETC-211100	Ranco						T775M2048		
ETC-212000	Ranco						T775B2032		
ETC-212100	Ranco						T775M2048		
ETC-24100	Ranco						T775B2016		

Table 7. Cross Reference. (Continued)

Features	Tekmar Model & T775 Cross															
	150 One Stage Setpoint Control	T775A2009	152 Two Stage Setpoint Control	T775B2032	256 One Stage Boiler Control	T7775P2003	T775R2035	260 One Stage Boiler & DHW Control	T7775P2003	T775R2035	262 Two Stage Boiler & DHW Control	T7775P2003	264 Our Stage Boiler & DHW Control	T775P2003	268 Nine Stage Boiler & DHW Control	T775P2003 & (2) T775S2008
Adjustable Minimum Off Time		✓		✓		✓	✓		✓	✓		✓		✓		✓
Auto Differential					✓			✓			✓		✓		✓	
Boiler Demand					✓	use DI	use DI	✓	use DI	use DI	✓		✓	use DI	✓	use DI
Built-in Display	✓	✓	✓	✓	✓	✓	✓	✓	✓	✓	✓	✓	✓	✓	✓	✓
Combustion Air or Alarm Contact						Digital Output for Alarm			Digital OutPut for Alarm			Digital Output for Alarm	Both	Digital Output for Alarm	Both	Digital Output for Alarm
DHW Control								✓			✓		✓		✓	
Digital Input for Setback or Disable		✓		✓	Boiler Demand	✓	✓	Boiler Demand	✓	✓	Boiler Demand	✓	Boiler Demand	✓	Boiler Demand	✓
Equal Run Time						✓			✓		✓	✓	✓	✓	✓	✓
External Input 0-10Vdc or 2-10Vdc													✓		✓	
First On / First Off Rotation						✓			✓			✓	✓	✓	✓	✓
First On/ Last OFF Rotation						✓			✓			✓	✓	✓	✓	✓
Fixed Last Rotation													✓		✓	
Fixed Lead Rotation													✓		✓	
Floating Output				✓			✓			✓						
Integral Voltage Options					Type based	✓		Type based	✓		Type based	✓	Type based	✓	Type based	✓
Irreversible High Set Point Limit		✓		✓		✓	✓		✓	✓		✓		✓		✓
Lo/ Hi or Hi/ Lo staging													✓		✓	
Modulating Outputs				(T775M2048)			T775R2027			T775R2027						
Nema 4x Models				(T775B2016)												
Optional Input Sensor								✓			✓					
Outdoor Reset					✓	✓	✓	✓	✓	✓	✓	✓	✓	✓	✓	✓
Power Supply Voltage	20 to 28 Vac	24, 120, 240 Vac	20 to 28 Vac	24, 120, 240 Vac	24Vac	24, 120, 240 Vac	24, 120, 240 Vac	120 Vac	24, 120, 240 Vac	24, 120, 240 Vac	120 Vac	24, 120, 240 Vac	115 Vac	24, 120, 240 Vac	115 Vac	24, 120, 240 Vac
Pump Exercising						✓		✓	✓		✓	✓	✓	✓	✓	✓
Pump Purging						✓		✓	✓		✓	✓	✓	✓	✓	✓
PWM Mode	✓															
Relay Rating	24 Vac	24, 120, 240 Vac	24 Vac	24, 120, 240 Vac	24, 120, 240 Vac	24, 120, 240 Vac	24, 120, 240 Vac	24, 120, 240 Vac	24, 120, 240 Vac	24, 120, 240 Vac	24, 120, 240 Vac	24, 120, 240 Vac	24, 120, 230 Vac	24, 120, 240 Vac	24, 120, 230 Vac	24, 120, 240 Vac
Relay Outputs	1 SPDT	1 SPDT	2 SPST	2 SPDT	1 SPST	4 SPDT	2 SPDT	1 SPST	4 SPDT	2 SPDT	2 SPST	4 SPDT	4 SPST	4 SPDT ²	9	12 SPDT ³
Sensor Calibration		✓		✓		✓	✓		✓	✓		✓		✓		✓
Sensor Inputs	1	1	2	2	2	3	2	3	3	2	5	3	3	3	3	3
Sensor Type	10kΩ at 77°F	1097Ω at 77°F	10kΩ at 77°F	1097Ω at 77°F	10kΩ at 77°F	1097Ω at 77°F	1097Ω at 77°F	10kΩ at 77°F	1097Ω at 77°F	1097Ω at 77°F	10kΩ at 77°F	1097Ω at 77°F	10kΩ at 77°F	1097Ω at 77°F	10kΩ at 77°F	1097Ω at 77°F
Time Clock with Setback		✓		✓	need external timer (tekmar Timer 031)	✓	✓	need external timer (tekmar Timer 031)	✓	✓	need external timer (tekmar Timer 031)	✓	need external timer (tekmar Timer 031)	✓	need external timer (tekmar Timer 031)	✓
Adjustable Interstage Delay	✓		✓			✓		✓	✓		✓	✓	✓	✓	✓	✓
Warm Weather Shut Down					✓	✓		✓	✓		✓	✓	✓	✓	✓	✓

¹ can be configured with up to two T775S expansion modules for a maximum of 12 stages
² if staging 4 relays and a pump output add one T775S2008 expansion module
³ if staging 9 relays and a pump output add two T775S2008 expansion modules

